



Installation / User Manual

APsystems Energy Communication Unit ECU-R



Please scan this QR code
to download our APPs

or click the link below:
<http://q-r.to/10rC>

© All Rights Reserved

Table of Contents

1. Introduction	2
2. Interface Explanation	3
2.1 Interface Layout.....	3
2.2 Reset.....	4
2.3 Power Connection Port.....	4
2.4 RJ45 Ethernet Network Port.....	4
2.5 RJ45 Signal (Only for Australia).....	4
2.6 Antenna.....	4
2.7 AP.....	5
2.8 LED1.....	5
2.9 LED2.....	5
3. Hardware Installation	6
3.1 Preparation.....	6
3.2 Selecting an Installation Location for the ECU-R.....	6
3.3 Installation.....	6
3.4 Cable Connection.....	7
3.5 Internet Connection.....	9
4. ECU-R User Interface	10
4.1 Commissioning the ECU-R.....	10
4.2 Enter microinverters UID (serial numbers) into the ECU-R.....	11
4.3 Historical ID.....	12
4.4 Delete UID.....	12
4.5 Grid Profile.....	13
4.6 Time management.....	14
4.7 Modbus Settings.....	14
4.8 ECU Network Settings.....	15
4.9 Checking the commissioning of the ECU-R.....	18
4.10 Module.....	19
4.11 Data.....	20
4.12 Inverter Connection Progress.....	20
4.13 Automatic System Check.....	21
4.14 ECU AP Settings.....	21
4.15 Do-It-Yourself(DIY) Registration.....	22
4.16 Settings.....	22
5. Technical Data	23
6. Contact Information	26

1. Introduction

The APsystems Energy Communication Unit (ECU-R) is the information gateway for our microinverters. The ECU-R collects module performance data from each individual microinverter and transfers the information to an Internet database in real time. Through the APsystems Energy Monitoring and Analysis (EMA) software, the ECU-R gives you precise analysis of each microinverter and PV module in your solar installation powered by APsystems. The user-friendly interface gives you access to your solar array performance in seconds from our web based portal or from our APP.

Features

- Collects individual PV module and microinverter statistics
- Communicates in real time
- Requires no additional wiring

The APsystems ECU-R is used in utility-interactive grid-tied applications, typically consisting of five key elements:

- APsystems microinverter(s)
- APsystems Energy Communication Unit (ECU-R)
- EMA Manager APP: for installer to set-up the ECU-R
- EMA APP: to enable end-users to have access to the data and performance of their system anytime, anywhere
- APsystems Energy Monitoring and Analysis (EMA): web-based monitoring and analysis system, for both end-users and installers

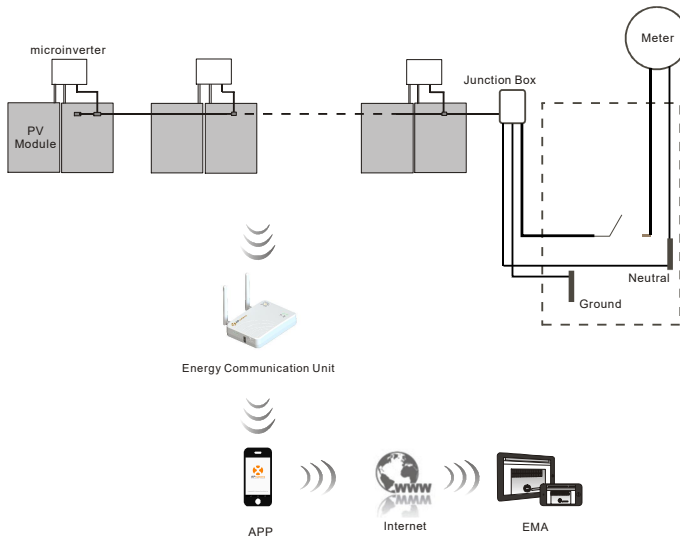

Figure 1

2. Interface Explanation

2.1 Interface Layout

The ECU-R interface includes, (figure 2) from left to right

- Reset button
- Wifi antenna connector (WLAN communication between ECU and router)
- power connection port
- RJ45 Signal port (for Australia only)
- RJ45 ethernet network port (LAN communication between ECU and router)
- Zigbee antenna connector (communication between ECU and microinverters)

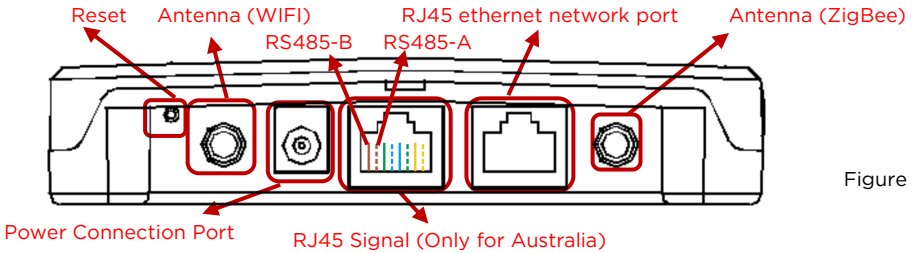

Figure 2

On the side ECU: from top to bottom are:

- USB port: for reserved.
- AP button: in case there is need to activate the ECU-R hotspot (see later in the document)

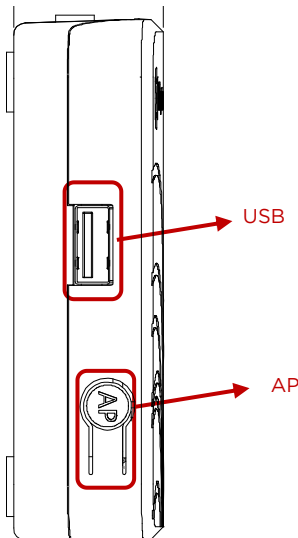

Figure 3

2. Interface Explanation

2.2 Reset

Press the Reset button for a minimum of three seconds: the ECU-R will automatically return to the default settings.

2.3 Power Connection Port

The power connection port connects power through the power adapter.

2.4 RJ45 Ethernet Network Port

The ECU-R allows the user to communicate with the EMA server via Ethernet cable.

2.5 RJ45 Signal (Only for Australia)

The RJ45 Signal is designed for DRMO, it should be connected by RJ45 connector in the package otherwise the inverter will not work.



NOTICE

Please do not plug out the RJ45.

2.6 Antenna

The antennas supplied with the ECU-R must be connected to the ECU-R. One antenna is used for the communication between ECU-R and microinverters (Zigbee signal), the other antenna is used for the Wi-Fi connection between ECU-R and router.

2. Interface Explanation

2.7 AP

The AP button enables to turn on the ECU wifi hotspot. When setting up the ECU, installer needs to first connect to the ECU hotspot via his smart phone or tablet.

Press the AP button for a few seconds: the ECU hotspot will be live for one hour. If more time is needed to set-up the ECU, press the AP button to reactivate the hotspot.

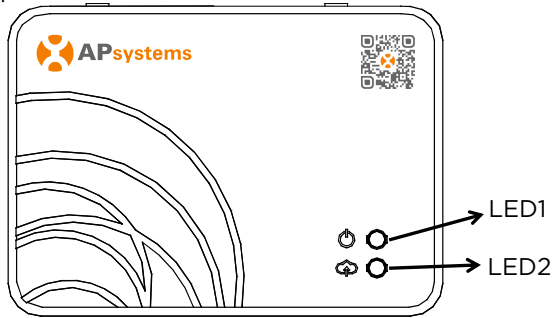

Figure 4

2.8 LED1

LED1 will be ON (green light) when the ECU is powered ON

2.9 LED2

LED2 will be ON (green light) when the ECU is exchanging data with the EMA server.

When you haven't entered microinverters UID into the ECU-R, or The ECU cannot connect to the EMA server, LED2 is OFF.

3. Hardware Installation

3.1 Preparation

Make sure you have the following components ready before beginning the installation of the ECU-R:

- A standard AC electrical outlet (located as close as possible of the PV array to ensure good communication between ECU and microinverters).
- A broadband Internet connection available for your use.
- A broadband router with either a CAT5 Ethernet, or a wireless router.
- A smartphone or tablet with EMA Manager APP ready to use (see page 11).

3.2 Selecting an Installation Location for the ECU-R

- Choose a location that is as close as possible of the PV array.
- The ECU-R is NOT rated for outdoor use. If installing outdoor, ensure that the ECU-R is put in a waterproof box, and that the antenna (wifi and Zigbee) are placed outside of the box to ensure optimum communication. In case you need to use extension antennas to be closer to the PV array, please make sure the extension antennas are Wifi 2.4GHz with SMA connectors male/female. These extension antennas are not supplied by APsystems, but can be purchased at any electrical/PV shop.

3.3 Installation

1) Using a Wall Mount

When mounting the ECU-R to a wall, make sure to select a cool, dry indoor location.

- Depending on the wall surface you are mounting the ECU-R to, use either two drywall screws or wall anchors, installed 100 mm apart (The drywall screws and wall anchors are not included in the ECU-R kit).
- Align and slide the ECU-R onto the mounting screws.

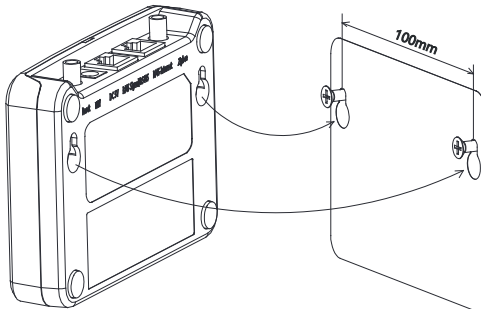

Figure 5

3. Hardware Installation

- 2) if the HECU-R is not mounted on a wall mount, you can put it anywhere on a flat surface or furniture, close to a power outlet.

3.4 Cable Connection

- 1) ECU-R outside of a cabinet (wall mounted or not)
 - Connect the adapter to the power connection port at the back of the ECU-R.

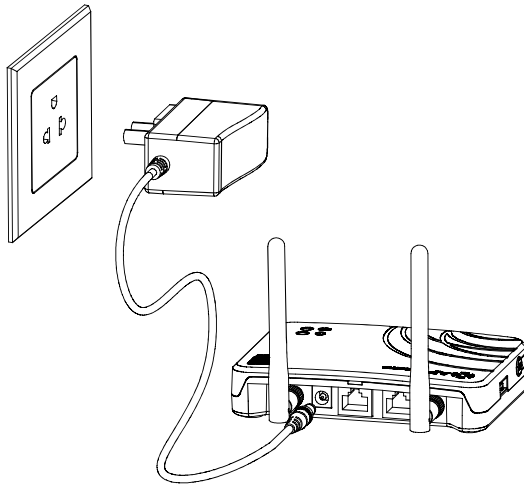

Figure 6

NOTICE

The antennas used for ZigBee port and WI-FI port are exactly the same type and are interchangeable.

3. Hardware Installation

2) Installation inside a power cabinet

- Install the socket on the guide rail (The socket is not be supplied by APsystems).
- Connect the adapter to the power connection port at the back of the ECU-R.

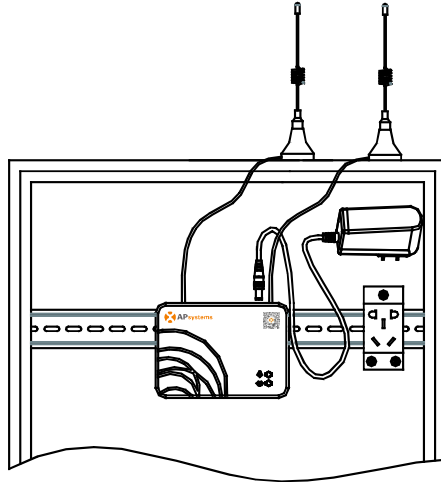

Figure 7

NOTICE

ECU antennas must be left outside of the cabinet, even if the cabinet is made of plastic. Please make sure the extension antennas are Wifi 2.4GHz with SMA connectors male/female. These extension antennas are not supplied by APsystems, but can be purchased at any electrical/PV shop.

3. Hardware Installation

3.5 Internet Connection

There are two different approaches to connect the ECU-R to the Internet:

Option 1: Direct LAN cable connection.

- 1) Make sure the LAN cable is connected to the network port on the back of the ECU-R.
- 2) Connect the LAN cable to a spare port on the broadband router.

See more info later in the document.



Figure 8

Option 2: Wireless Connection.

Use ECU-R internal WLAN (see later in the document, page 15).

NOTICE

ECU-R can communicate with the microinverters up to 76 meters (250 ft) with direct sight.

ECU-R can utilize WiFi (WLAN) up to 9 meters (30 ft) with direct sight.

NOTICE

4G router is also supported. ECU can be connected to 4G router by wifi or LAN.

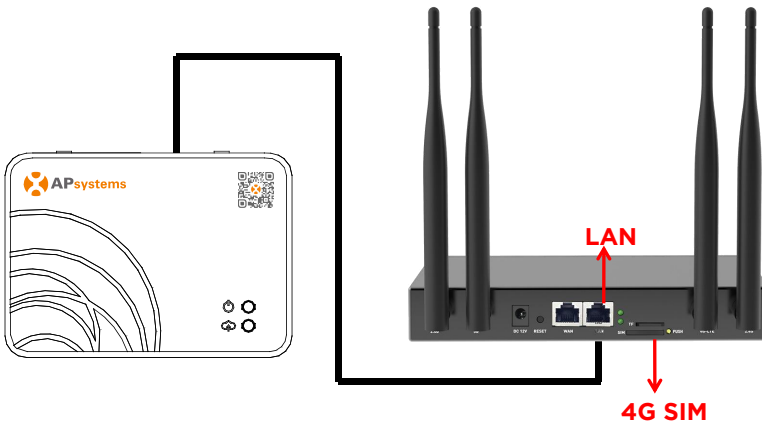

Figure 9

4. ECU-R User Interface

Please scan QR code below to have access to our products and APP catalogue, or click this link to download our APPs: <http://q-r.to/1OrC>.



- EMA Manager APP: for installers
 - Professional installers: all features available
 - DIY (Do It Yourself) installers: only ECU_APP features available
- EMA APP: for end-users only

4.1 Commissioning the ECU-R

- Make sure you have downloaded the EMA Manager APP on your smartphone or tablet.
- Make sure the ECU-R hotspot is activated (if not, press the AP button for a few second).
- Open Settings > Wi-Fi in your smartphone or tablet.
- Select ECU-R hotspot: name is ECU_R_216xxxx (mimicking ECU-R serial number).
- Connect your smartphone or tablet to the ECU-R hotspot. Default password is “88888888” (8 times 8).
- Once the connection is established with the ECU-R hotspot, open the EMA Manager APP.
- Select “**ECU APP**” to enter into the commissioning tool (you can access to ECU APP without any login or password).

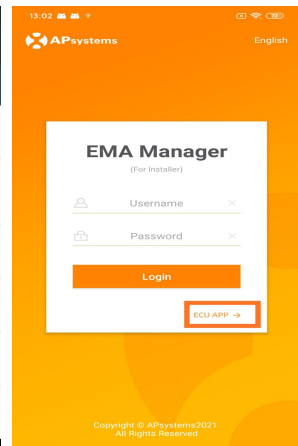
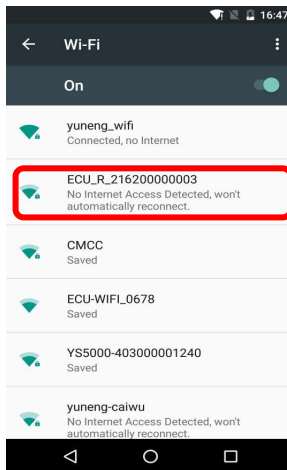
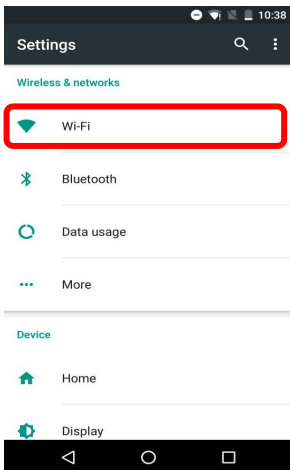

4. ECU-R User Interface

4.2 Enter microinverters UID (serial numbers) into the ECU-R

- Click “Workspace”, select “ID Management”, input the microinverters UID (serial number: 12 digits starting with a 4, a 5, a 7 or a 8) manually or scan the UID with your smartphone or tablet scanner.
- Once the microinverters UID have been entered, please press “Sync”.

 **NOTICE**

Please do not enter the ECU UID into the ID management menu (serial number of 12 digits starting with 216-).

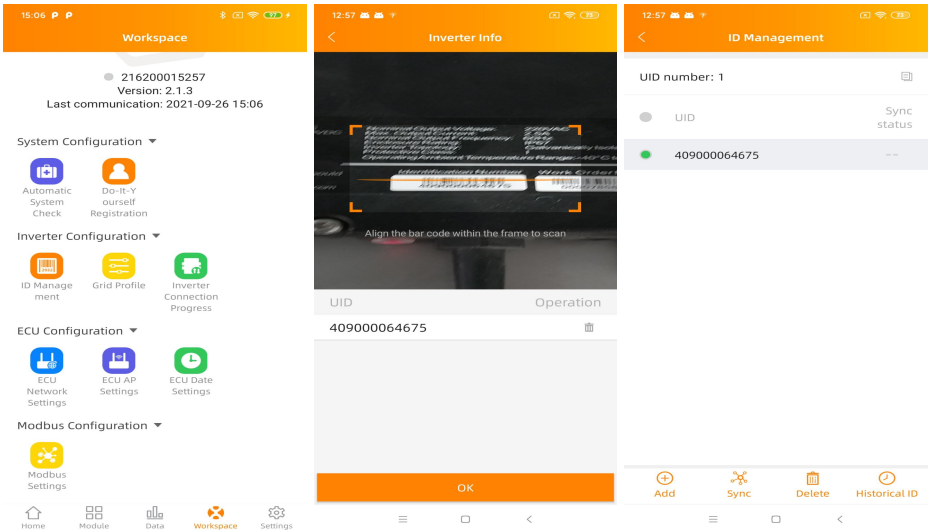

4. ECU-R User Interface

4.3 Historical ID

- If the ECU accidentally emptied the inverter list, you can use the same mobile phone to quickly restore the inverter id list.

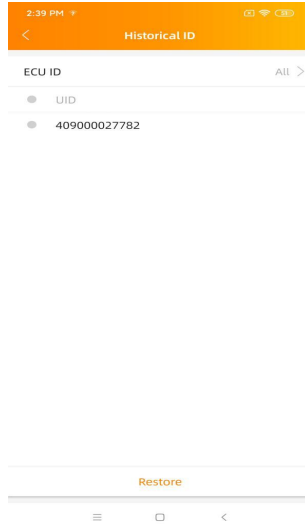

4.4 Delete UID

- In case of wrong entry or typo, select the microinverter UIDs, click “Delete” then click “Sync”. The selected UID(s) will be removed from the ECU-R.
- Note: when deleting, please press also “Sync”. Otherwise the microinverter will not be removed from the ECU-R.

Once the microinverters UID have been successfully entered into the ECU-R, you need to select grid profile and define the adequate time zone of your ECU.

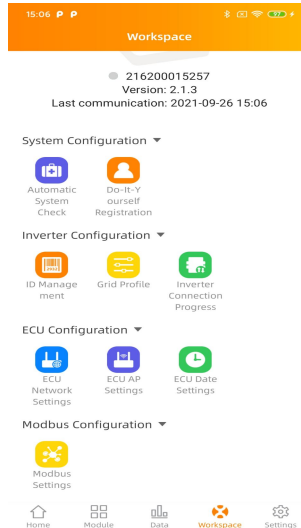

4. ECU-R User Interface

4.5 Grid Profile

- From the work space, select “Grid profile”.
- First select country and then the city.

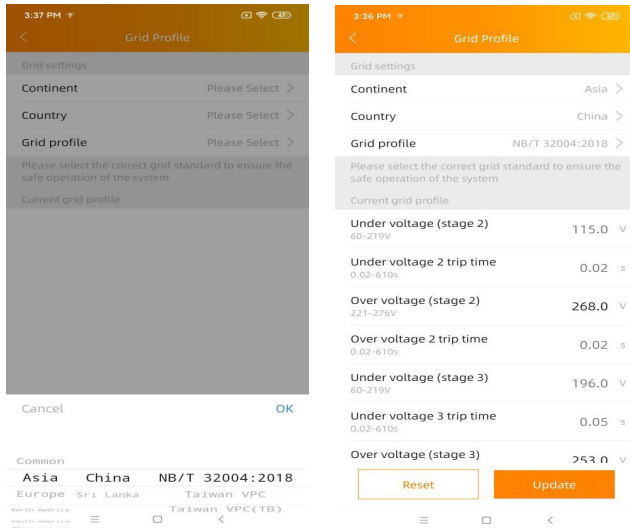

NOTICE

If you select the wrong grid profile, the microinverters may not start or may not produce as per optimal performance.

4. ECU-R User Interface

4.6 Time management

- From the workspace, please select menu “ECU Date Settings” manual set-up, click “Date”, “Time” and “Timezone” to modify.
- Automated set-up: Click “Time quick setting”: the APP will synchronise on the time and time zone as per smartphone or tablet settings.

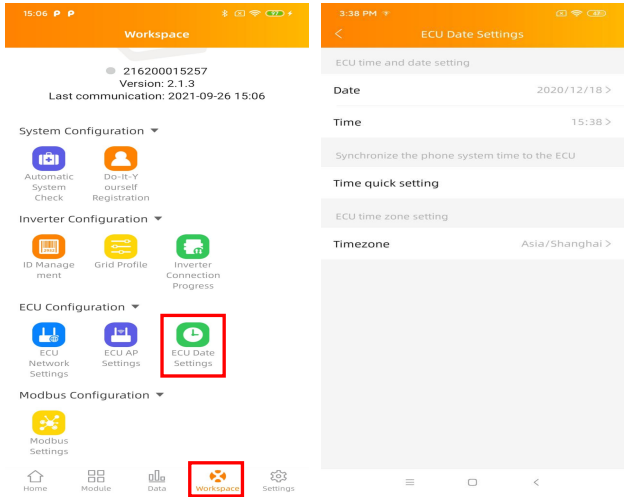

4.7 Modbus Settings

NOTICE

As shown in Figure 9 below, RS485 interface is on the bottom of the ECU. It can be connected by Serial line.

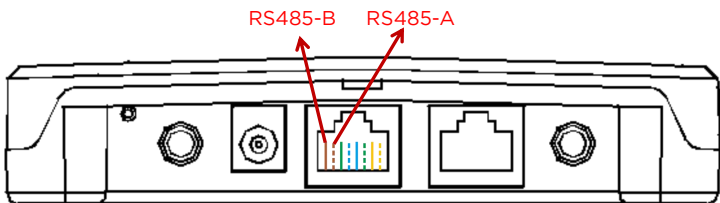

Figure 10

For three-phase Microinverter: Please refer to the document [Altenergy_Power_System_Inc. ___three_phase_microinverter_11-12.xlsx](https://certifications.sunspec.org/PICS/Altenergy Power System Inc. ___three_phase_microinverter_11-12.xlsx) on SunSpec website.
https://certifications.sunspec.org/PICS/Altenergy Power System Inc. ___three_phase_microinverter_11-12.xlsx

4. ECU-R User Interface

For single-phase Microinverter: Please refer to the document Altenergy_Power_System_Inc.____single_phase_MicroinverterAPpcs_11-12 on SunSpec website.

https://certifications.sunspec.org/PICS/Altenergy_Power_System_Inc.____single_phase_MicroinverterAPpcs_11-12.xlsx

- Click Modbus Settings in the Workspace, switch on the SunSpec Modbus function. Select the baud rate and configure Inverters' address in the address text box. Finally, click Save to finish configuration.
- The host's RS485 port must be configured to the same baud rate, 8 data bits, 1 stop bit, none parity bit.

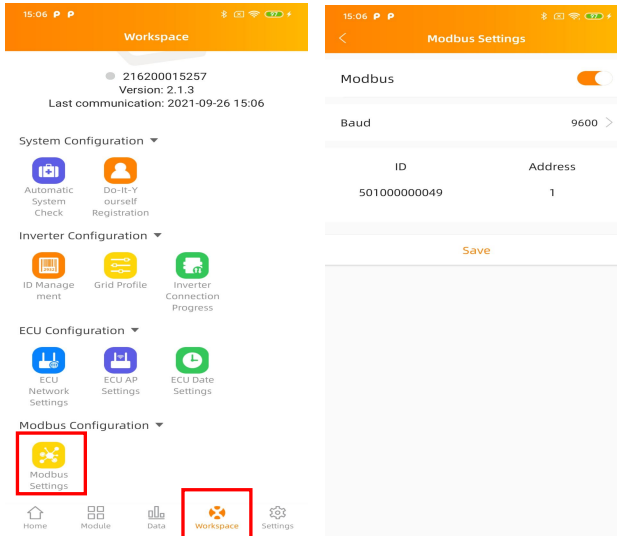

4.8 ECU Network Settings

4.8.1 WLAN

- From the Workspace menu, select "ECU Network settings".
- Swipe down the screen, the available SSIDs will be displayed .
- Select the network of your choice and enter its password.
- When connecting to the local Wifi, the smartphone or tablet may lose its connection to the ECU hotspot and connect to other wifi network or 4G.
- If more operations are needed to finish-up the ECU commissioning, please make sure to reconnect your smartphone or tablet to the ECU hotspot (may have to press the AP button to re-activate the hotspot).

4. ECU-R User Interface

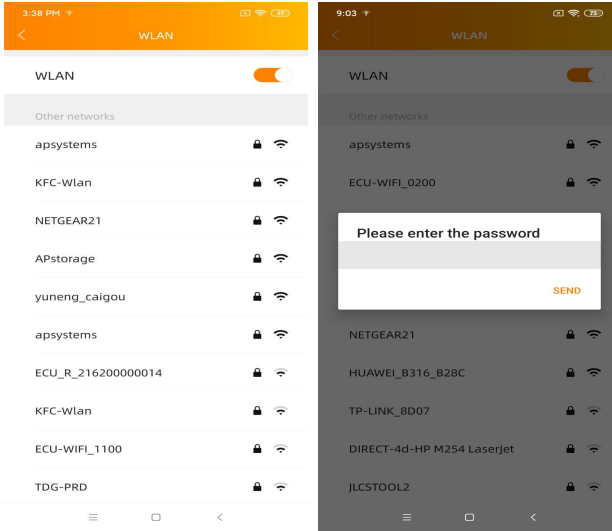

- When your smartphone or tablet is connected to the ECU hotspot again, you can open the ECU APP home page and check the internet connection status.
- The first bullet (with ECU UID) is green when the smartphone/tablet is properly connected to the ECU hotspot.
- The 2nd bullet shall be green if the internet connection to the router has been successfully established.

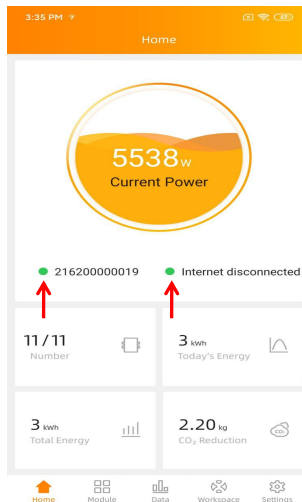

4. ECU-R User Interface

4.8.2 LAN

- Make sure the LAN cable is connected to the network port on the back of the ECU-R.
- Connect the LAN cable to a spare port on the broadband router.
- ECU's wired network setting has 2 options:
- automatically obtain an IP address: the router will give an IP address to the ECU-R automatically (preferred method) .
- use a fixed IP address. In that case, you need to enter enter IP address, subnet mask, default gateway, Preferred DNS server and Alternate DNS server.

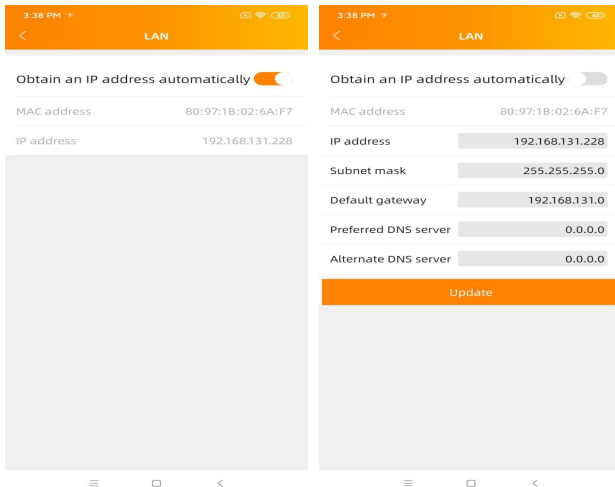

- Once the LAN connection has been established, you can check the internet connection on the home page of the ECU APP:
- The first bullet (with ECU UID) is green when the smartphone/tablet is properly connected to the ECU hotspot.
- The 2nd bullet shall be green if the internet connection to the router has been successfully established.

4. ECU-R User Interface

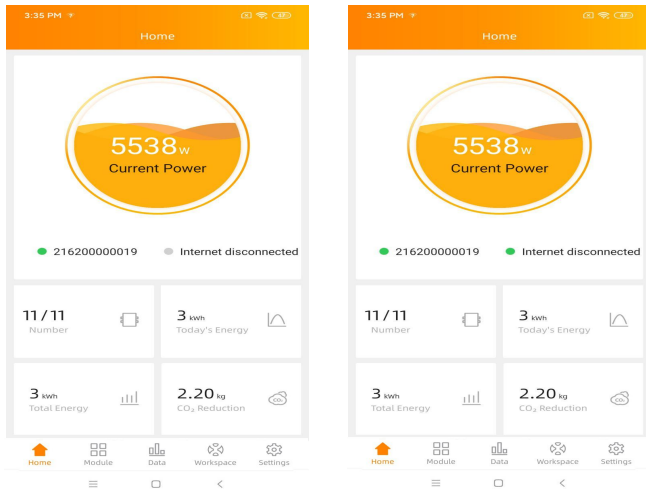

4.9 Checking the commissioning of the ECU-R

- Once the ECU-R has been commissioned, installer can check status on the home page of the ECU APP:
- Several infos are displayed
 - Systems info (ECU UID, serial number)
 - number of microinverters communicating with the ECU / total number of microinverters entered in the ECU (using the ID Management menu).

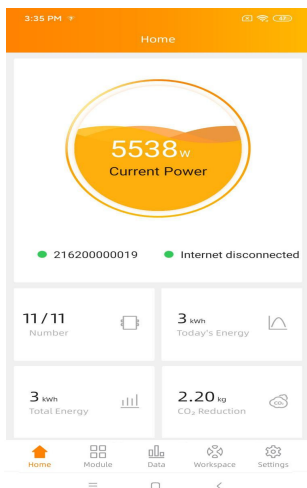

4. ECU-R User Interface

- Status of connectivity
- The traffic light (on the left) in front of the ECU UID shows connectivity status between smartphone or tablet and ECU hotspot:
 - Smartphone or tablet is connected to the ECU hotspot.
 - Smartphone or tablet is not connected to the ECU hotspot. Please try again by pressing the AP button.
- The traffic light (on the right) shows connectivity status between the ECU and the local internet:
 - The ECU is connected to the local internet.
 - The ECU is not connected to the internet.

Other info visible from the home page power output of the day
-Total power output since installation
-CO₂Reduction since installation.

4.10 Module

- This page displays the microinverters entered in the ECU (via the Menu ID Management) and properly registered by the ECU. A dual microinverter will be shown by default with 2 PV modules, while a quad microinverters will be shown by default with 4 PV modules. if some DC channels are not connected on purpose, the ECU_APP will nonetheless continue to display the maximum number of panels which can be connected to a given microinverter.
- Removing un-used channel needs to be done from the EMA installer account when creating end-user account.
- On the module page, installer can visualize the performance of microinverters registered into the ECU.
- Click “Panel”: the detailed information of the microinverter is displayed, including inverter UID, PV module DC power, grid voltage, frequency and temperature.

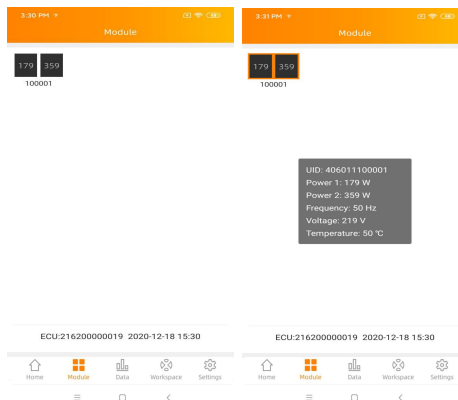

4. ECU-R User Interface

4.11 Data

- In this Menu, you can view the detailed data at system level:
 - Per day
 - Per month

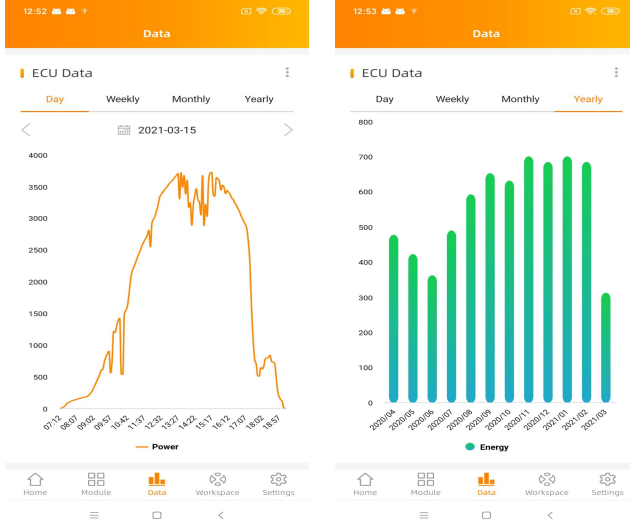

4.12 Inverter Connection Progress

- This menu shows the connection progress and communication quality between microinverter and ECU, 100% means the connection is over.

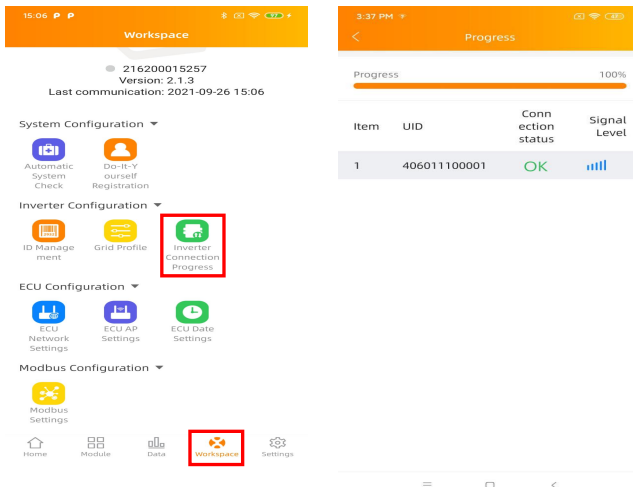

- The microinverters with "OK" are properly connected to the ECU

4. ECU-R User Interface

4.13 Automatic System Check

- Once the ECU has been commissioned, the menu “Automatic System Check” can help you to check proper communication and production of each microinverter.
- This menu also gives some basic troubleshooting tips.

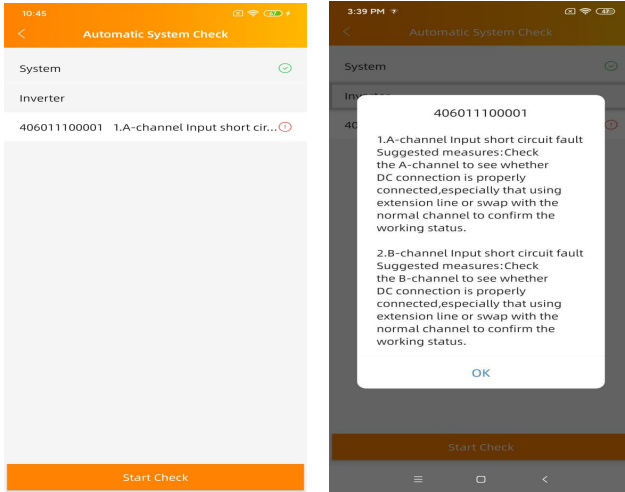

4.14 ECU AP Settings

- This menu can be used if you would like to change the default password of the ECU-R hotspot.
- Please connect to the ECU hotspot first, open the menu “ECU APP settings” and change the password at your convenience.
- If doing a reset of the ECU, password will be reinitialized as 88888888.

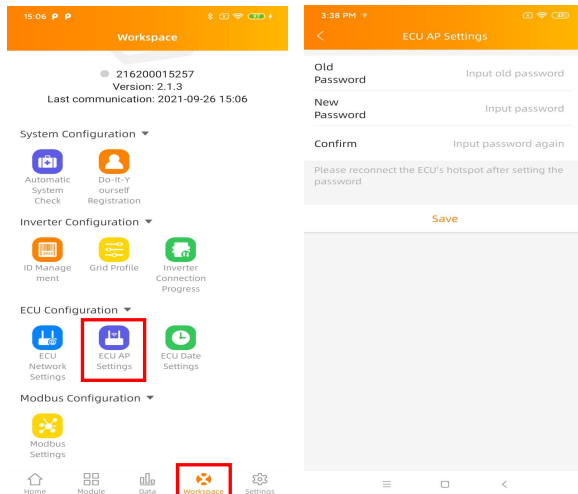

4. ECU-R User Interface

4.15 Do-It-Yourself(DIY) Registration

- This menu is only for DIY installers: it will allow DIY installer to create their EMA account by themselves. They can later on access to their account via the EMA APP.
- Once the ECU has been properly commissioned, make sure to connect your smartphone or tablet to local internet.
- Enter “Do it Yourself Registration Menu” and follow instructions to create your own EMA account.

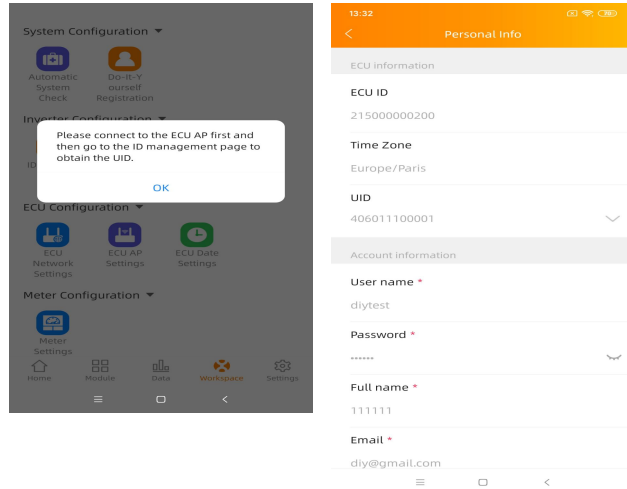

4.16 Settings

- This basic menu allows you to change the Language: English, French, Spanish, Portuguese, Polish, Simplified Chinese and traditional Chinese. We're adapting to more languages.

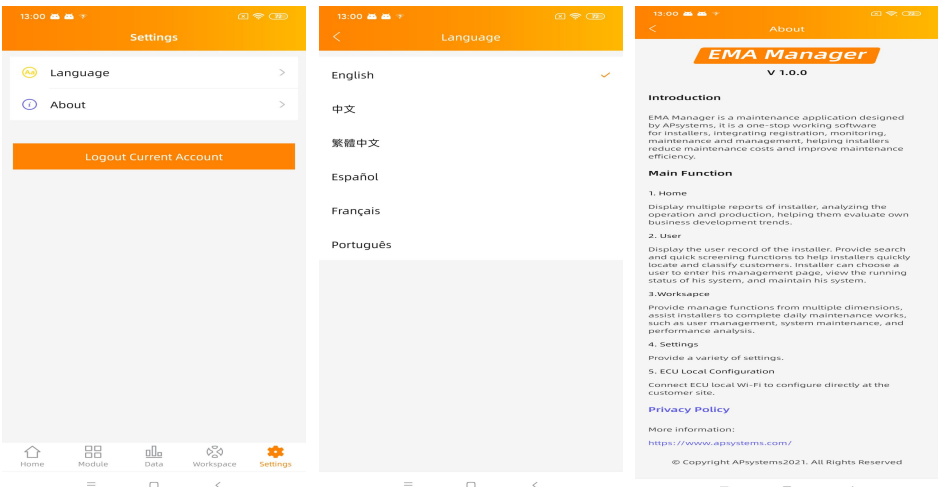

5. Technical Data

Communication to Microinverter	
Communication	ZigBee 2.4 GHz
Maximum Communicating Inverter*	100
Communication to EMA	
Ethernet	10/100M Auto-sensing, Auto-negotiation
Wireless	Wi-Fi 802.11g/n /GSM Cellular
Wireless Security	WEP, WPA2-PSK
USB Port	For Reserved
Power Requirements	
AC Adapter	5V, 2A
Power Consumption	1.7W
Mechanical Data	
Dimensions (W×H×D)	122mm×87mm×25mm (4.8"×3.4"×0.98")
Weight	150g (0.33lbs)
Ambient Temperature Range	-20°C to +65°C (-4°F to +149°F)
Cooling	Nature Convection; No Fans
Enclosure Environmental Rating	Indoor - NEMA 1 (IP20)
Features	
Compliance	IEC 60950-1, EN60950-1, IEC 60529, EN 60529, ANSI/UL 60950-1, CAN/CSA C22.2 No.60950-1, UL50E, FCC part 15, EN61000-6-1, EN61000-6-3, ICES-003, AS NZS 60950-1, GB/T17799

*Maximum number of microinverters per ECU may vary depending on the PV array size and layout, maximum distance between ECU and microinverters in the array, obstacles (thick concrete wall, metallic roof top).

Specifications subject to change without notice.
Please ensure you are using the most recent update found at www.APsystems.com.

This Class B digital apparatus complies with Canadian ICES-003.

5. Technical Data

:: **WEEE** (for Europe)



Disposal of your old appliance

1. When this crossed-out wheeled bin symbol is attached to a product, it means the product is covered by the European Directive 2002/96/EC.
2. All electrical and electronic products should be disposed of separately from the municipal waste stream via designated collection facilities appointed by the government or the local authorities.
3. The correct disposal of your old appliance will help prevent potential negative consequences for the environment and human health.
4. For more detailed information about disposal of your old appliance, please contact your city office, waste disposal service or the shop where you purchased the product.

CAUTION

The professional person is allowed to replace the battery.

Do not ingest battery, Chemical Burn Hazard.

This product contains a coin/button cell battery. If the coin/button cell battery is swallowed, it can cause severe internal burns in just 2 hours and can lead to death. Keep new and used batteries away from children. If you think batteries might have been swallowed or placed inside any part of the body, seek immediate medical attention.

5. Technical Data

This device complies with Part 15 of the FCC Rules. Operation is subject to the following two conditions: (1) this device may not cause harmful interference, and (2) this device must accept any interference received, including interference that may cause undesired operation.

Please note that changes or modifications not expressly approved by the party responsible for compliance could void the user's authority to operate the equipment.

Note: This equipment has been tested and found to comply with the limits for a Class B digital device, pursuant to Part 15 of the FCC Rules. These limits are designed to provide reasonable protection against harmful interference in a residential installation. This equipment generates, uses and can radiate radio frequency energy and, if not installed and used in accordance with the instructions, may cause harmful interference to radio communications. However, there is no guarantee that interference will not occur in a particular installation. If this equipment does cause harmful interference to radio or television reception, which can be determined by turning the equipment off and on, the user is encouraged to try to correct the interference by one or more of the following measures:

- Reorient or relocate the receiving antenna.
- Increase the separation between the equipment and receiver.
- Connect the equipment into an outlet on a circuit different from that to which the receiver is connected.
- Consult the dealer or an experienced radio/TV technician for help.

6. Contact Information

ALTENERGY POWER SYSTEM Inc.

www.APsystems.com

APsystems Jiaxing China

No. 1, Yatai Road, Nanhu District, Jiaxing, Zhejiang

Tel: +86 573 8398 6967

Mail: info@altenergy-power.com

APsystems Shanghai China

B305 No. 188, Zhangyang Road, Pudong, Shanghai

Tel: +86 021 3392 8205

Mail: info@altenergy-power.com

APsystems Australia

Suite 502, 8 Help Street, Chatswood NSW 2067 Australia

Tel: +61 (0)2 8034 6587

Mail: info@altenergy-power.com

APsystems America

600 Ericksen Ave NE, Suite 200 Seattle, WA 98110

Tel: 844-666-7035

Mail: info@APsystems.com

APsystems Europe

Rue des Monts dor ZAC de Folliouses Sud-Les Echets 01700 Miribel, France

Tel: +33-481 65 60 40

Mail: emea@APsystems.com

Cypresbaan 7, 2908 LT,Capelle aan den Ijssel The Netherlands

Tel: +31-10-2582670

Mail: info.emea@APsystems.com

APsystems Mexico

AV. Lazaro Cardenas 2850-5° Piso, Colonia Jardines del Bosque C.P. 44520, Guadalajara, Jalisco

Tel:52 (33) -3188-4604

01 800 890 6030

Mail: info.latam@APsystems.com