



# Installation / User Manual

## APsystems YC1000-3 Photovoltaic 3-Phase Grid-connected Microinverter

Rev 3.6



Please scan the QR code to get mobile app and more support to help the installation.

ALTENERGY POWER SYSTEM Inc.  
WEB: [www.APsystems.com](http://www.APsystems.com)

APsystems Australia  
Suite 502, 8 Help Street, Chatswood NSW 2067 Australia  
TEL: 61 (0)2 8034 6587      EMAIL: [info@altenergy-power.com](mailto:info@altenergy-power.com)

© All Rights Reserved

(For Australia / New Zealand)

# Table of Contents

<b>Important Safety Instructions.....</b>	<b>2</b>
Radio interference statement.....	2
Safety Instructions.....	3
Symbols replace words on the equipment, on a display.....	3
<b>APsystems YC1000-3 System Introduction.....</b>	<b>4</b>
<b>APsystems Three-phase Microinverter YC1000-3.....</b>	<b>6</b>
<b>APsystems Microinverter System Installation.....</b>	<b>7</b>
Additional Installation components from APsystems.....	7
Required Parts and Tools from you.....	7
Installation Procedures.....	8
Step 1 - Lay the AC bus according to the arrangement of APsystems Microinverter.....	8
Step 2 - Attaching the APsystems Microinverters to the Racking.....	8
Step 3 - Attaching the antenna to the Microinverter, and keep the antenna vertical to the earth.....	8
Step 4 - Connecting the APsystems Microinverter AC Cables to the AC bus cable.....	9
Step 5 - Connecting APsystems Microinverters to the PV Module.....	9
Step 6 - Install a protective end cap at the end of AC bus cable.....	10
Step 7 - Installing the AC Branch Circuit Isolator.....	10
Step 8 - Completing the APsystems Installation Map.....	11
<b>APsystems microinverter system operating instructions.....</b>	<b>11</b>
<b>Troubleshooting.....</b>	<b>13</b>
Status Indications and Error Reporting.....	13
Troubleshooting a non-operating APsystems Microinverter.....	14
<b>Replace a microinverter.....</b>	<b>15</b>
<b>Technical Data.....</b>	<b>16</b>
APsystems YC1000-3 Microinverter Datasheet.....	17
<b>Wiring Diagram.....</b>	<b>18</b>
Sample Wiring Diagram - Three Phase.....	18

# Important Safety Instructions

This manual contains important instructions to follow during installation and maintenance of the APsystems Photovoltaic Grid-connected Inverter (Microinverter). To reduce the risk of electrical shock and ensure the safe installation and operation of the APsystems Microinverter, the following symbols appear throughout this document to indicate dangerous conditions and important safety instructions.

**SAVE THESE INSTRUCTIONS!** *This manual contains important instructions for models YC1000-3 that must be followed during Installation and maintenance of the Photovoltaic Grid-connected Inverter.*

Specifications subject to change without notice - please ensure you are using the most recent update found at [www.APsystems.com](http://www.APsystems.com)

---

**WARNING:** This indicates a situation where failure to follow instructions may cause a serious hardware failure or personnel danger if not applied appropriately. Use extreme caution when performing this task.

---



**WARNING  
SYMBOL**

---

**NOTE:** This indicates information that is important for optimized Microinverter operation. Follow these instructions closely.

---



**NOTE  
SYMBOL**

---

**NOTE:** Pollution degree 1: no pollution or only dry, non-conductive pollution occurs. The pollution has no influence.

---

## Radio interference statement

RCM/C-TICK Compliance: The equipment can comply with the limits from RCM/C-TICK requirement, which are designed to protect against harmful interference in a residential installation. The equipment could radiate radio frequency energy and this might cause harmful interference to radio communications if not following the instructions when installing and using the equipment. But there is no guarantee that interference will not occur in a particular installation. If this equipment causes harmful interference to radio or television reception, the following measures might resolve the issues:

- A) Relocate the receiving antenna and keep it well away from the equipment
- B) Consult the dealer or an experienced radio/TV technical for help.





Changes or modifications not expressly approved by the party responsible for compliance may void the user's authority to operate the equipment.

# Important Safety Instructions

## Safety Instructions

- ✓ **Do NOT** disconnect the PV module from the APsystems Microinverter without first disconnecting the AC power.
- ✓ Only qualified professionals should install and/or replace APsystems Microinverters.
- ✓ Perform all electrical installations in accordance with local electrical codes.
- ✓ Before installing or using the APsystems Microinverter, please read all instructions and cautionary markings in the technical documents and on the APsystems Microinverter system and the solar-array.
- ✓ Be aware that the body of the APsystems Microinverter is the heat sink and can reach a temperature of 80°C. To reduce risk of burns, do not touch the body of the Microinverter.
- ✓ **Do NOT** attempt to repair the APsystems Microinverter. If it fails, contact APsystems Customer Support (61 (0)2 8034 6587) to obtain an RMA number and start the replacement process. Damaging or opening the APsystems Microinverter will void the warranty.
- ✓ **Do NOT** expose the connection to directed, pressurized liquid (water jets, etc.).
- ✓ **Do NOT** expose the connection to continuous immersion.
- ✓ **Do NOT** expose the AC connector to continuous tension (e.g., tension due to pulling or bending the cable near the connection).
- ✓ Use only the connectors and cables provided.
- ✓ **Do NOT** allow contamination or debris in the connectors.
- ✓ Use the cable and connectors only when all parts are present and intact.
- ✓ Use the terminator to seal the conductor end of the Engage Cable; no other method is allowed.

## Symbols replace words on the equipment, on a display

	<b>Dangerous electrical voltage</b> This device is directly connected to public grid, thus all work to the inverter shall only be carried out by qualified personnel.
	<b>NOTICE, danger!</b> This device directly connected with electricity generators and public grid.
	<b>Danger of hot surface</b> The components inside the inverter will release a log of heat during operation, DO NOT touch aluminum housing during operating.
	<b>An error has occurred</b> Please go to Chapter 10 “Trouble Shooting” to remedy the error.
	<b>This device SHALL NOT be disposed of in residential waste</b> Please go to Chapter 9 “Recycling and Disposal” for proper treatments.

# APsystems YC1000-3 System Introduction

The APsystems Microinverter is used in utility-interactive grid-tied applications, comprised of three key elements:

- APsystems Microinverter
- APsystems Energy Communication Unit (ECU)
- APsystems Energy Monitor and Analysis (EMA) web-based monitoring and analysis system

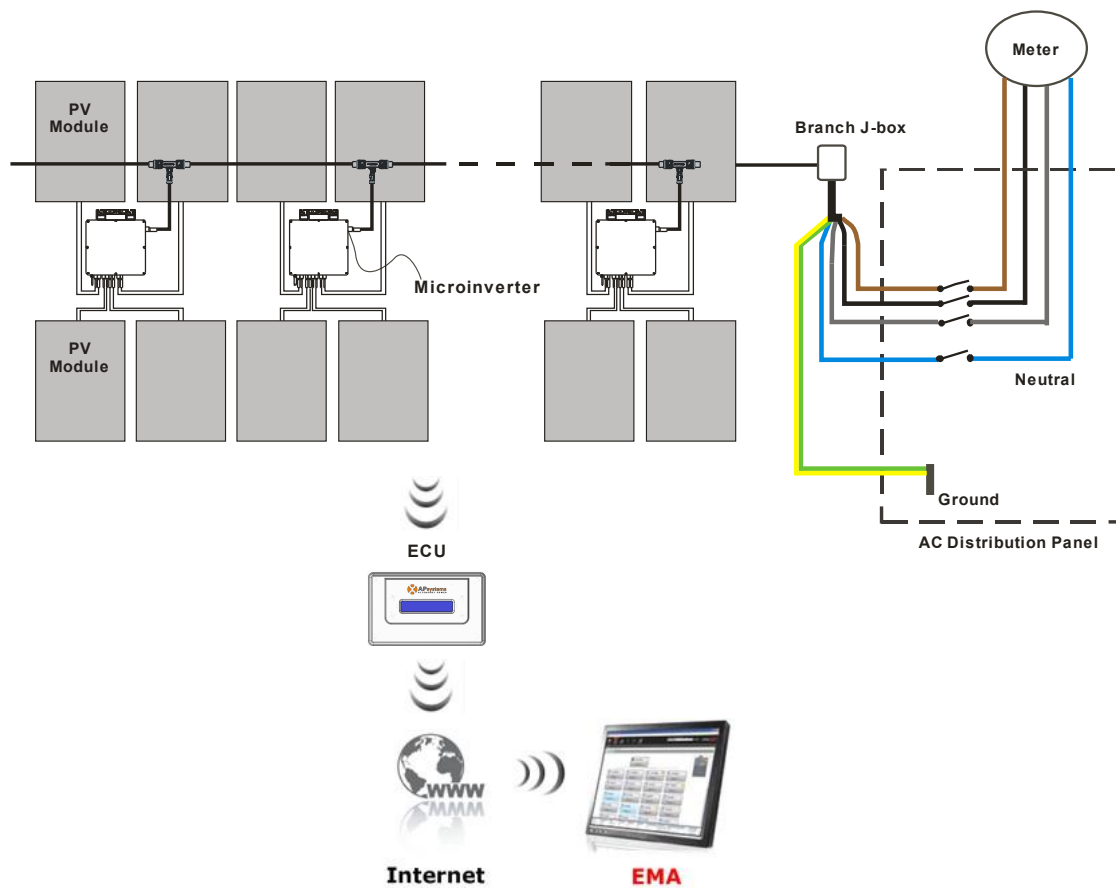

Figure 1

# APsystems YC1000-3 System Introduction

This integrated system improves safety; maximizes solar energy harvest; increases system reliability, and simplifies solar system design, installation, maintenance, and management.

## **APsystems Microinverters maximize PV energy production**

The Apsystems microinverter ensures top performance from the array by maximizing the performance of the module within the array when PV modules in the array are affected by shading.

## **More reliable than centralized or string inverters**

The distributed microinverter system ensures that no single point of system failure exists across the PV system. Apsystems microinverters are designed to operate at full power at ambient temperatures of up to +65°C (+149° F). The inverter housing is designed for outdoor installation and complies with the IP67 environmental enclosure rating.

## **Simple to install**

You can install individual PV modules in any combination of module quantity, orientation, different type and power rate (check on-line module compatibility or contact Apsystems).

## **Smart system performance monitoring and analysis**

The Apsystems Energy Communication Unit (ECU) is installed by simply plugging it into any wall outlet and providing it with an Ethernet or Wi-Fi connection to a broadband router. After installing and setting the ECU (see ECU manual), the full network of Apsystems Microinverters automatically reports to the Apsystems Energy Monitor and analysis (EMA) web server. The EMA software displays performance trends, informs you of abnormal events, and controls system shutdown when it is needed. Reference the ECU Manual for installation and operation instructions.

## APsystems Three-phase Microinverter YC1000-3

The APsystems YC1000-3 Microinverters connect with the Three-phase grid, and operate with most 60, 72, 84 and 96 cell PV modules. For more information, please see the Technical Data page (p.16) of this manual.

<b>Model Number</b>	<b>AC grid</b>	<b>PV Module</b>	<b>Max. # Per branch</b>	<b>Module Connector</b>
YC1000-3	230V/400V	60,72,84, 96 Cell	12 per 20A×3 Breaker for 2.5mm <sup>2</sup> AC BUS	MC-4 Compatible or Customize

# APsystems Microinverter System Installation

A PV system using ASystems Microinverters is simple to install. Each Microinverter easily mounts on the PV racking, directly beneath the PV module(s). Low voltage DC wires connect from the PV module directly to the Microinverter, eliminating the risk of high DC voltage. Installation **MUST** comply with local regulations and technical rules.

Special Statement! *An AC GFCI device **should not** be used to protect the dedicated circuit to the ASystems microinverter even though it is an outside circuit. None of the small GFCI devices (5mA-30 mA) are designed for back feeding and will be damaged if back feed. In a similar manner, AC AFCIs have not been evaluated for back feeding and may be damaged if back feed with the output of a PV inverter.*

---

**WARNING:** Perform all electrical installations in accordance with local electrical codes.

---

---

**WARNING:** Be aware that only qualified professionals should install and/or replace ASystems Microinverters.

---

---

**WARNING:** Before installing or using an ASystems Microinverter, please read all instructions and warnings in the technical documents and on the ASystems Microinverter system itself as well as on the PV array.

---

---

**WARNING:** Be aware that installation of this equipment includes the risk of electric shock.

---

---

**WARNING:** Do not touch any live parts in the system, including the PV array, when the system has been connected to the electrical grid.

---

---

**WARNING:** Electrical Installation & Maintenance shall be conducted by licensed electrician and shall comply with national wiring rules.

---

---

**NOTE:** Strongly recommend to install Surge protection Devices in the dedicated meter box.

---



## Additional Installation components from ASystems

- Sealing caps (sold separately)
- Protective end cap (sold separately)

## Required Parts and Tools from you

In addition to your PV array and its associated hardware, you will need the following items:

- An AC connection junction box
- Mounting hardware suitable for module racking
- Sockets and wrenches for mounting hardware
- Continuous grounding conductor and grounding washers
- A Phillips screwdriver
- A torque wrench



# Installation Procedures

APsystems Microinverters are designed to only operate when they can sense power coming from the grid. Even if they are plugged into the solar array, they will not turn themselves on until they can read power from the grid.

---

**WARNING:** Do NOT connect APsystems Microinverters to the utility grid or energize the AC circuit until you have completed all of the installation procedures as described in the following sections.

---



## Step 1 - Lay the AC bus according to the arrangement of APsystems Microinverter

## Step 2 - Attaching the APsystems Microinverters to the Racking

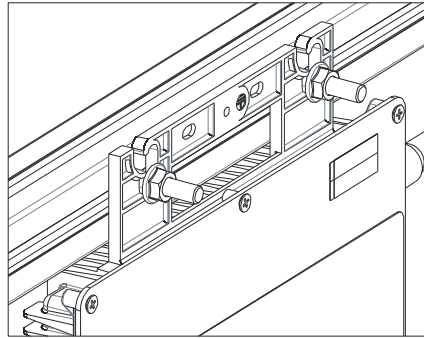
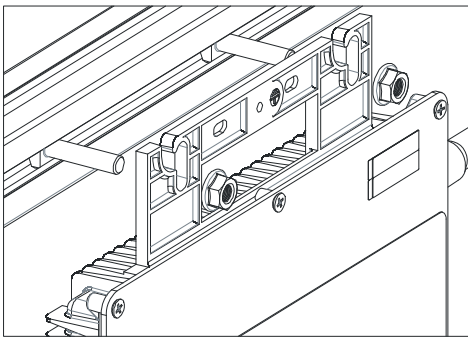

Figure 2

- Mark the location of the Microinverter on the rack, with respect to the PV module junction box or any other obstructions.
- Mount one Microinverter at each of these locations using hardware recommended by your module racking vendor.

---

**WARNING:** Prior to installing any of the microinverters, verify that the utility voltage at the point of common connection matches the voltage rating on microinverter label.

---



---

**WARNING:** Do not place the inverters (including DC and AC connectors) Where exposed to the sun, rain or snow, even gap between modules. Allow a minimum of 3/4" (1.5cm.) between the roof and the bottom of the Microinverter to allow proper air flow.

---



## Step 3 - Attaching the antenna to the Microinverter, and keep the antenna vertical to the earth

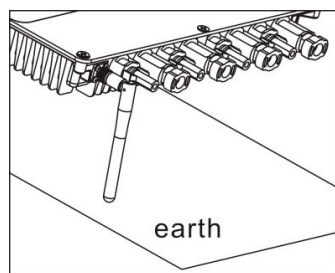
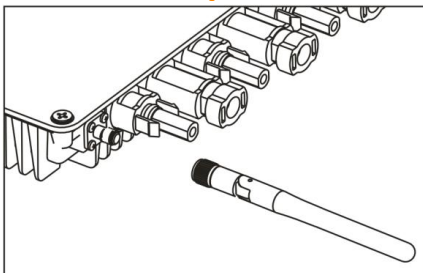

Figure 3

# Installation Procedures

## Step 4 - Connecting the APsystems Microinverter AC Cables to the AC bus cable

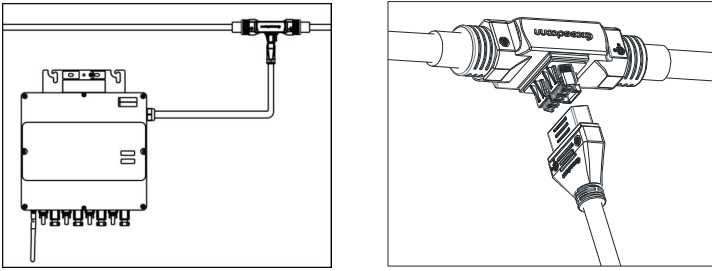

Figure 4

Cover all unused T connectors with sealing caps to protect the T connectors.

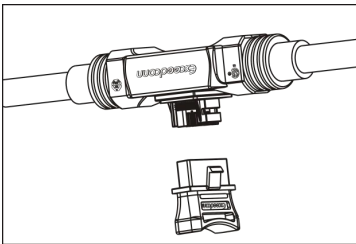

Figure 5

AC connector interface as follows, from left to right PE, N, L3, L2, L1.

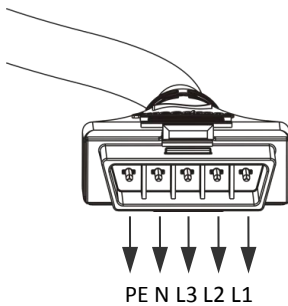

Figure 6

## Step 5 - Connecting APsystems Microinverters to the PV Module

Place the PV modules into position on the racking and connect the DC input cables to the microinverters based on optimum layout configuration (up to four PV modules per microinverter).

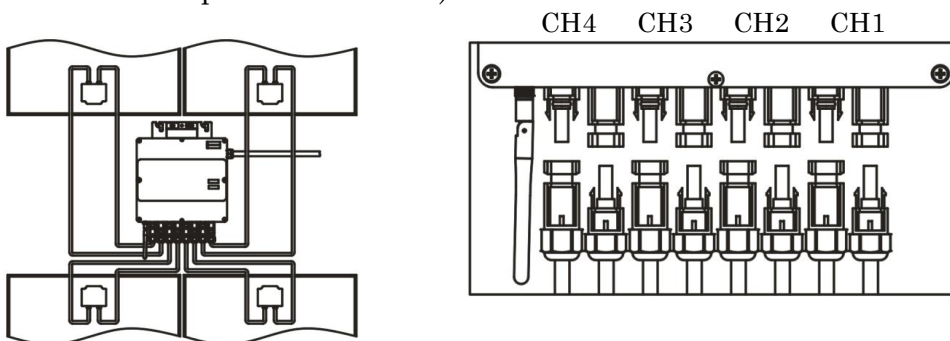

Figure 7

**NOTE:** The status LED for on each microinverter will blink green three (3) times to indicate normal operation once DC power is applied. It is important to understand that this “start up” sequence occurs once the first module is connected to the microinvert and is successfully generating DC power. The “start up” sequence does NOT reoccur as additional modules are connected to the same microinverter.



# Installation Procedures

## Step 6 - Install a protective end cap at the end of AC bus cable

a. Wirestripping  
18mm~25mm

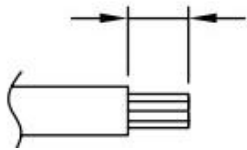

c. Insert five wires into five cable clamps

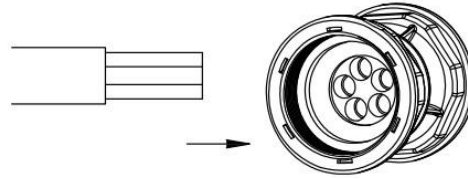

b. Insert the cable end into the gasket clamp.

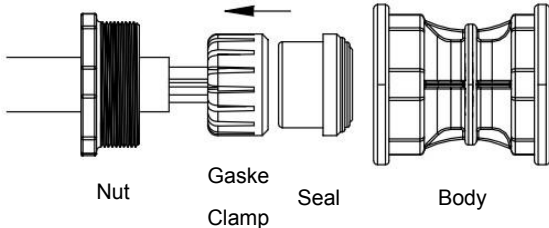

d. Rotate the nut with 2.5N·m until the latching mechanism meets the base.

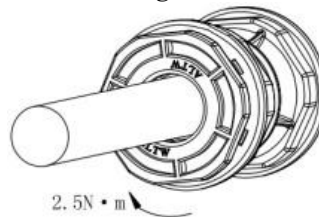

Figure 8

## Step 7 - Installing the AC Branch Circuit Isolator

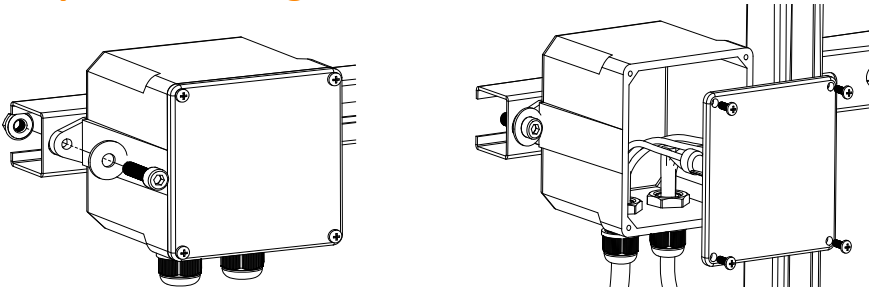

Figure 8

- Install an appropriate junction box at a suitable location on the PV racking system (typically at the end of a branch of modules).
- Connect the open wire end of the AC bus cable into the junction box using an appropriate gland or strain relief fitting.
- Wire the conductors of the AC bus: L1- BROWN; L2 - BLACK; L3 - GREY; N - LIGHT BLUE; PE – YELLOW GREEN.**
- Connect the AC branch circuit junction box to the point of utility interconnection.

**WARNING:** Wiring colour code can be different according local regulation, check all the wires of the installation before connecting to the AC bus to be sure they match. Wrong cabling can damage irreparably the microinverters, such an issue is not covered by the warranty.



**WARNING:** Double check to make sure all of the AC and DC wiring has been correctly installed. Ensure that none of the AC and/or DC wires are pinched or damaged. Make sure that all of the junction boxes are properly closed.



## Step 8 - Completing the APsystems Installation Map

Fill in the APsystems Warranty Cards, which provide system information and the installation map. Feel free to provide your own layout if a larger or more intricate installation map is required. The layout map provided is designed to accommodate labels in vertical or horizontal orientation to meet all the field PV connections.

- a. Each APsystems microinverter has removable serial number labels. Peel labels off, and affix one to the respective location on the APsystems installation map, and affix another to the PV module frame which is easy to see. The warranty cards can be obtained from the appendix of this manual or APsystems website: [www.APsystems.com](http://www.APsystems.com)
- b. Fill out the warranty cards and email to APsystems at [support@APsystems.com](mailto:support@APsystems.com).
- c. Register the system using your Installer Account on the APsystems EMA. You can then use the EMA website to view detailed performance of the PV system.

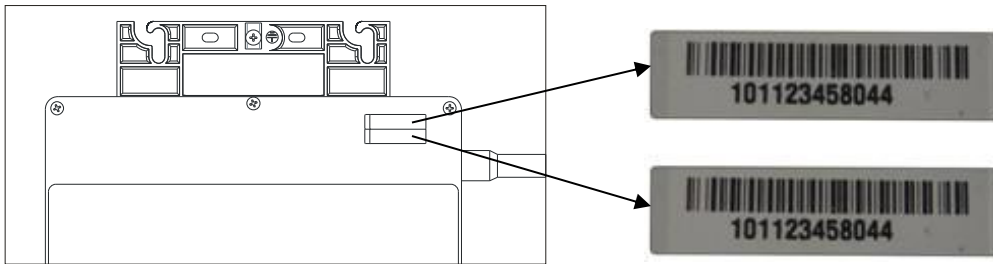

Figure 10

- 
- NOTE:**
1. Step 1~8 can change sequence for convenience of installation.
  2. Warranty card is located in Appendix last page of this manual.
  3. You can use Scanning Gun or mobile phone with APsystems ArrayApp to scan the serial numbers on the map when set ECU (see ECU manual).
  4. Using apsystems' mobile app ArrayApp can make the installation and registration much more simple.
- 



## To operate the ASystems microinverter PV system:

1. Turn ON the AC circuit breaker on each microinverter AC branch circuit.
2. Turn ON the main utility-grid AC circuit breaker. Your system will start producing power after a five-minute safety delay period.
3. The ASystems Microinverters will start to send performance data over wireless to the ECU. The time required for all the microinverters in the system to report to the ECU will vary with the number of microinverters in the system. You can verify proper operation of the ASystems Microinverters via the ECU. See the ECU Installation and Operation Manual for more information.

# Troubleshooting

Qualified personnel can use the following troubleshooting steps if the PV system does not operate correctly:

## Status Indications and Error Reporting

### Start up LED

Three (3) short green blinks, when DC power is first applied to the microinverter, indicates a successful microinverter start up. It is important to understand that this “start up” sequence occurs once the first module is connected to the microinvert and is successfully generating DC power. The “start up” sequence does NOT reoccur as additional modules are connected to the same microinverter.

### Operation LED

**Flashing Slow Green (10 sec. gap)** - Producing power and communicating with ECU

**Flashing Fast Green (2 sec. gap)** - Producing power and not communicating with ECU over 60 minutes

**Flashing Red** - Not producing power

**Steady Red** - Electrode assembly ground fault protection

### Other Faults

All other faults are reported to the ECU. Refer to the ECU Installation and Operation Manual for a list of additional faults and troubleshooting procedures.

---

**WARNING:** Only qualified personnel should directly handle the APsystems microinverter.

---



---

**WARNING:** Never disconnect the DC wire connectors under load. Ensure that no current is flowing in the DC wires prior to disconnecting. An opaque covering may be used to cover the module prior to disconnecting the module.

---



---

**WARNING:** Always disconnect AC power before disconnecting the PV module wires from the APsystems microinverter.

---



---

**WARNING:** The APsystems microinverter is powered by PV module DC power. Make sure you disconnect and reconnect the DC connections to watch for the three short LED flashes indicating start up.

---



## Troubleshooting a non-operating APsystems Microinverter

**To troubleshoot a non-operating APsystems Microinverter, Follow the steps below in order:**

1. Verify the utility voltage and frequency are within ranges shown in the Technical Data section of this manual.
2. Check the connection to the utility grid. Verify utility power is present at the inverter in question by removing AC, then DC power. **Never disconnect the DC wires while the microinverter is producing power.** Re-connect the DC module connectors and watch for three short LED flashes.
3. Check the AC branch circuit interconnection between all the microinverters. Verify each inverter is energized by the utility grid as described in the previous step.
4. Make sure that any AC breaker are functioning properly and are closed.
5. Check the DC connections between the microinverter and the PV module.
6. Verify the PV module DC voltage is within the allowable range shown in the Technical Data of this manual.
7. If the problem persists, please call APsystems Technical Support.

---

**WARNING:** Do not attempt to repair the APsystems microinverter. If troubleshooting methods fail, please call APsystems Customer Support.

---



# Replace a microinverter

Qualified personnel can use the following troubleshooting steps if the PV system does not operate correctly:

## Follow the procedure to replace a failed APsystems Microinverter.

- A. Remove the APsystems microinverter from the PV Module, in the following order:
  1. Disconnect the AC by turning off the branch circuit breaker.
  2. Cover the module with an opaque cover.
  3. Disconnect the first AC connector in the branch circuit.
  4. Disconnect the PV module DC wire connectors from the microinverter.
  5. Remove the Microinverter from the PV array racking.
- B. Remove the opaque cover, install a replacement Microinverter to the rack. Remember to observe the flashing LED light as soon as the new Microinverter is plugged into the DC cables.
- C. Connect the AC cable of the replacement Microinverter.
- D. Close the branch circuit breaker, and verify operation of the replacement Microinverter.



## Technical Data

---

**WARNING:** Be sure to verify the voltage and current specifications of your PV module match with those of the Microinverter. Please refer to the datasheet or usermanual which can be download from APsystems website [www.APsystems.com](http://www.APsystems.com).

---



---

**WARNING:** You must match the DC operating voltage range of the PV module with the allowable input voltage range of the APsystems Microinverter.

---



---

**WARNING:** The maximum open circuit voltage of the PV module must not exceed the specified maximum input voltage of the APsystems microinverter.

---



# APsystems YC1000-3 Microinverter Datasheet

**Region**

Australia, New Zealand

**Model**

YC1000-3-SAA

## Input Data (DC)

MPPT Voltage Range	16V-55V
Operation Voltage Range	16V-55V
Maximum Input Voltage	60V
Startup Voltage	22V
Maximum Input Current	14.8A x 4

## Output Data (AC)

3-Phase Grid Type	230V/400V
Maximum Continuous Output Power	900W
Peak Output Power	1000W
Nominal Output Current	1.30A×3
Nominal Output Voltage	230V×3
Default Output Voltage Range	200V-270V*
Extended Output Voltage Range	149V-278V
Nominal Output Frequency	50Hz
Default Output Frequency Range	47.5Hz-50.05Hz*
Extended Output Frequency Range	45.1Hz-54.9Hz
Power Factor	>0.99
Total Harmonic Distortion	<3%
Maximum Units per Branch	12 for 20A×3 Breaker**

## Efficiency

Peak efficiency	95%
CEC Weighted efficiency	94.5%
Nominal MPPT efficiency	99.9%
Night Power Consumption	300mW

## Mechanical Data

Operating ambient temperature range	-40 °C to +65 °C
Storage temperature range	-40 °C to +85 °C
Dimensions (W x H x D)	259mm x 242mm x 36mm
AC BUS Maximum Current	20A
Weight	3.8kg
Enclosure rating	IP67
Cooling	Natural Convection - No Fans
Maximum altitude rating	All data at this technical Specifications has been tested under <2000m

## Features

Communication	Zigbee
Transformer Design	High Frequency Transformers, Galvanically Isolated
Integrated ground	The DC circuit meets the requirements for ungrounded PV arrays in NEC690.35. Equipment ground is provided by the PE in the AC cable. No additional ground is required. Ground fault protection (GFP) is integrated into the microinverter.
Safety Class Compliance	AS3100/ IEC62109-1/ IEC62109-2
Grid Connection Compliance	AS 4777.2/AS 4777.3

\*Programmable through ECU in field to meet customer need.

Specifications subject to change without notice - please ensure you

\*\* Depending on the local regulations.

are using the most recent update found at [www.APsystems.com](http://www.APsystems.com)

© All Rights Reserved

2016/12/22 REV3.6

## Sample Wiring Diagram - Three Phase

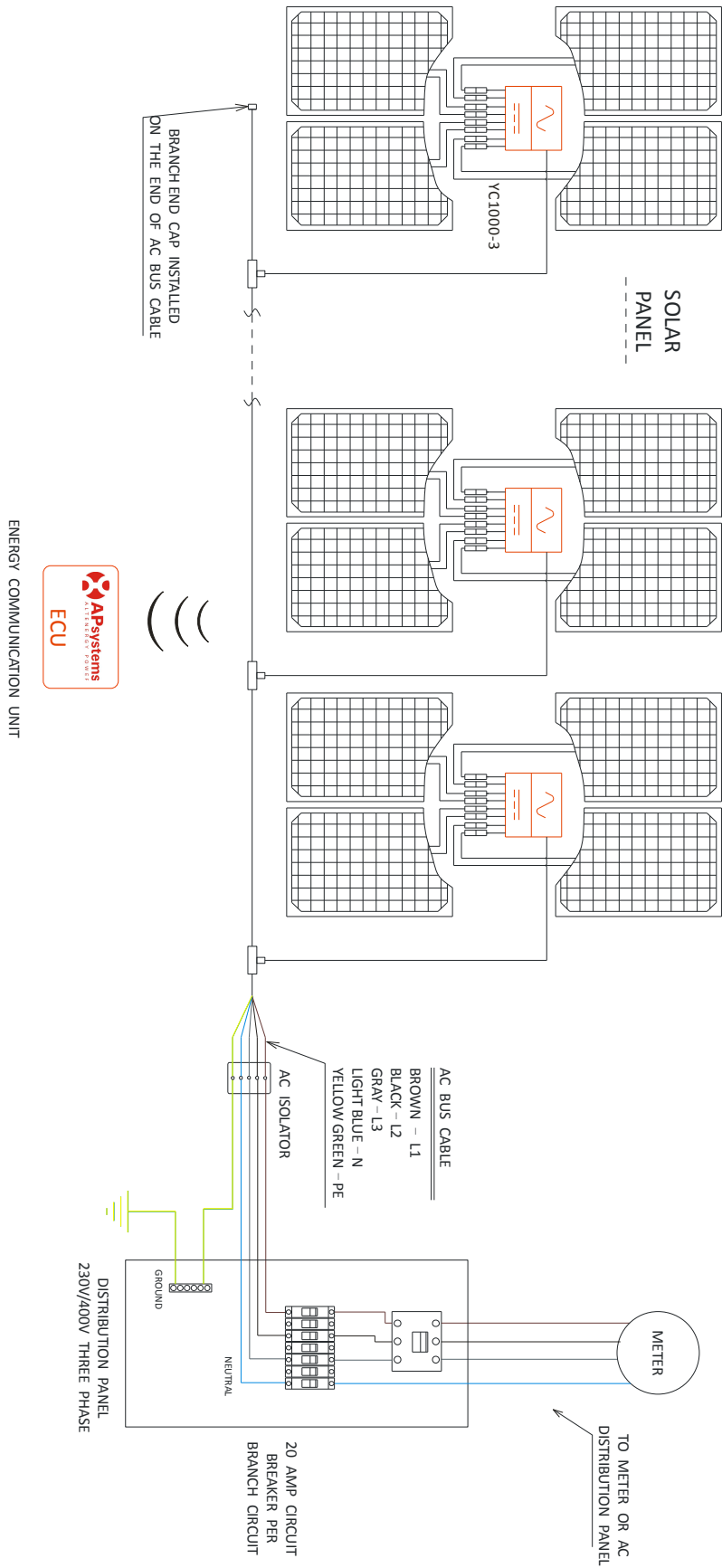

Figure 11

