



Installation / User Manual

APsystems Three-phase ECU-3 (V3)

Three-phase Energy Communication Unit

Rev 3.0

Table of Contents

Introduction.....	2
Interface Explanation.....	3
Interface position.....	3
Power Interface.....	3
RS232 Serial Port.....	3
Network Port.....	4
USB Interface.....	4
Reset.....	4
Hardware Installation.....	5
Preparation.....	5
Selecting an Installation Location for the ECU.....	5
Cable Connections.....	7
Internet Connection.....	7
Connect the AC Power Line.....	8
ECU Initialization Sequence.....	9
Step 1: Power on ECU.....	9
Step 2: ECU time zone setting.....	11
Step 3: EMA Monitoring.....	11
Basic Operation.....	12
Menu Structure.....	12
Restore the factory set operation.....	14
Troubleshooting.....	14
Local Network Interface.....	15
Connecting to the ECU via the LAN.....	15
Connecting Directly to the ECU.....	15
Home Screen.....	17
Real-time Data Screen.....	18
Configuration Screen.....	18
Administration Screen.....	20
Remote ECU Management (EMA).....	26
ECU Configuration/ECU Status Page.....	27
Setting the ECU Time Zone.....	28
Managing Inverter IDs and Updating the Inverter ID List.....	28
Technical Data.....	30

Introduction

The APsystems Communicator, our state-of-the-art Energy Communication Unit (ECU), is the information gateway for our microinverters. The unit collects module performance data from each individual microinverter and transfers this information to an Internet database in real time, requiring only a single data and power cable. Through the APsystems Monitor software, the APsystems Communicator gives you precise analysis of each microinverter and module in your solar installation from any web-connected device. The APsystems Communicator's integrated http webserver offers the simplest and most flexible network integration of any data logger on the market. The user-friendly browser-based interface lets you access your solar array in seconds.

Features

- Collects individual module and microinverter statistics
- Communicates in real time
- Requires no additional wiring

The APsystems Microinverter is used in utility-interactive grid-tied applications, and is made up of three key elements:

- APsystems Microinverter
- APsystems Energy Communication Unit (ECU)
- APsystems Energy Monitor and Analysis (EMA) web-based monitoring and analysis system

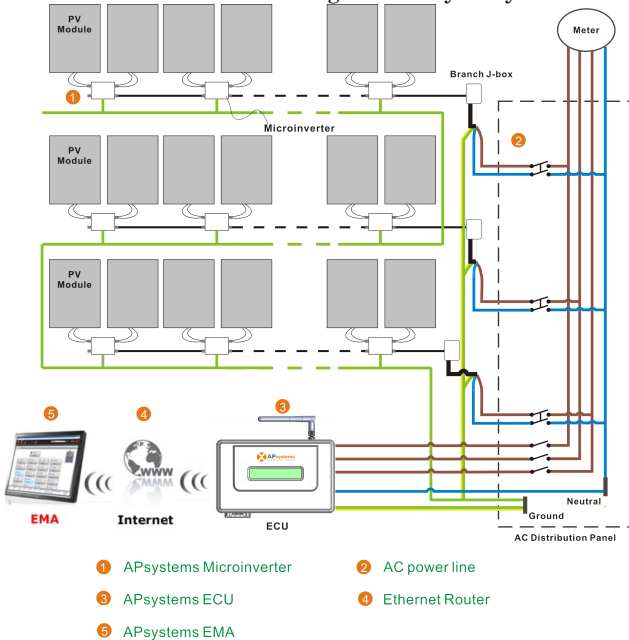

Figure 1

Interface Explanation

Interface position

All of the ECU interface as below, from left to right, are power connection port, serial port, network port, USB interface and reset.

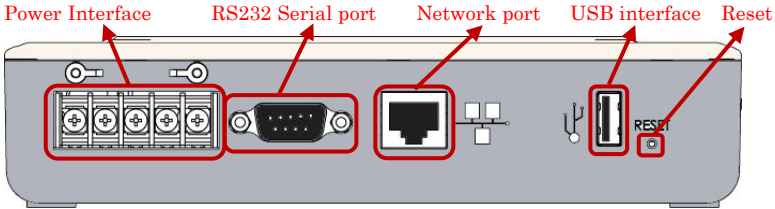

Figure 2

Power Interface

Power interface connects power through the power line.

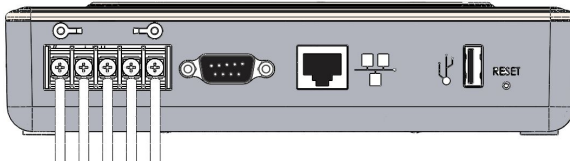

Figure 3

RS232 Serial Port

You can connect GPRS module to RS232 serial port, select GPRS module to connect to the network on “Network Connectivity” page, and communicate with the EMA, to check the system data.

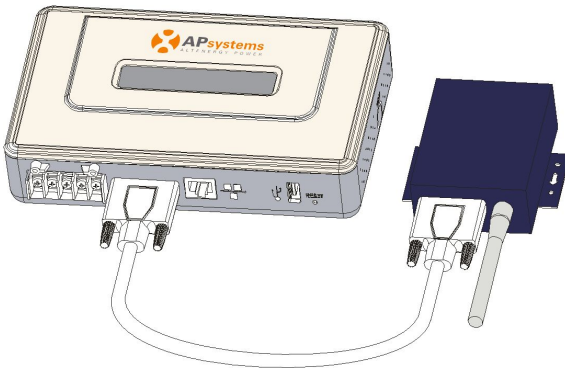

Figure 4

Interface Expalnation

Network Port

RJ45 Ethernet network port: ECU allows user to communicate with EMA, and log in ECU's local page, set up the system and view the system data via Ethernet network port. In the case of the absence of the wired network, user can select optional WiFi-Bridge wireless Internet.

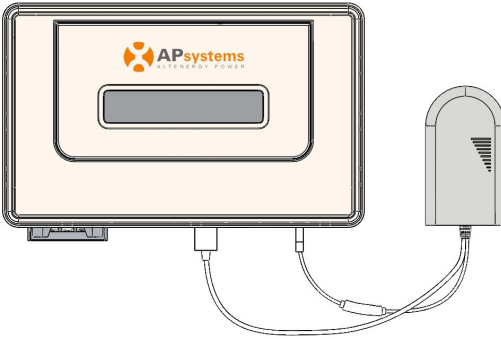

Figure 5

USB Interface

In the case of the absence of the wired network, user can select optional WiFi-Bridge wireless Internet. USB interface only provides 5V DC power supply for the WiFi-Bridge.

Reset

Press the “Reset” button for three seconds or longer, ECU will automatically return to the default settings.

NOTE: The historical power generation won't be cleared.



Hardware Installation

Preparation

Make sure you have the following things taken care of before attempting to install the ECU:

- Three-phase AC power line.
- A broadband Internet connection is available for your use.
- A broadband router with either a CAT5 Ethernet, or wireless router is available for your use.
- A laptop with a web browser (to view the APsystems EMA online monitoring application).
- A pre-programmed Three-phase ECU.

Selecting an Installation Location for the ECU

- A location that is electrically as close to the array as is possible-preferably a dedicated outlet installed directly to the solar system sub-panel.
- The ECU is NOT rated for outdoor use, so if installing outdoors near a junction box or breaker panel, making sure that you enclose it in an appropriate weather proof NEMA electrical box.

1) Using Electrical Mounting Din Rail

- Loosen the two (2) M3 mounting screws on the back of the ECU and rotate the two (2) rail holders so that the holders are above the ECU.

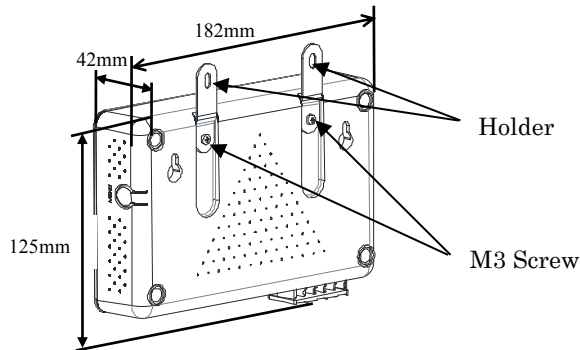

Figure 6

Hardware Installation

- Attach the ECU to the mounting rail with machine screws.

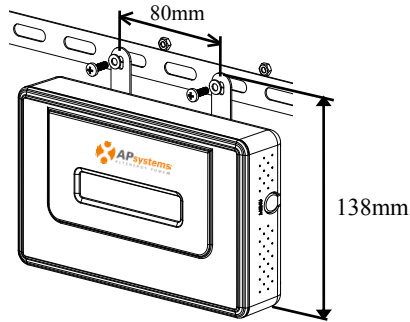

Figure 7

2) Using Wall Mount

When mounting the ECU to a wall, make sure to select a cool, dry, indoor location.

- Depending on the wall surface you are mounting the ECU to, use either two (2) #8 drywall screws or wall anchors, installed 130 mm apart. The drywall screws and wall anchors are NOT included in the ECU kit.
- Align and slide the ECU onto the mounting screws.

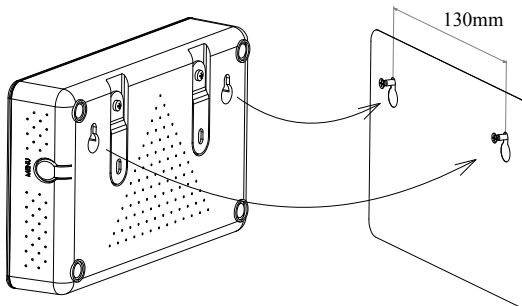

Figure 8

***Best Practice:** Install and connect the ECU to the Internet (see below instructions) while the rest of the array is being installed. Doing so allows the ECU to automatically update its internal software while the rest of the physical installation is underway. The ECU will then communicate with the inverters when the installation is complete and the array is energized.*

Hardware Installation

Cable Connections

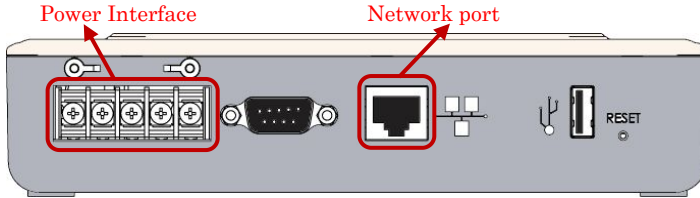

Figure 9

- Connect the power cable to the power interface on the bottom of the ECU.
- Connect the supplied LAN cable to the network port on the bottom of the ECU.

Internet Connection

There are three different approaches to connecting the ECU to the Internet:

Option 1: Direct LAN cable connection.

- 1) Make sure the LAN cable is connected to the network port on the bottom of the ECU.
- 2) Connect the LAN cable into a spare port on the broadband router.



Figure 10

Option 2: Wireless Connection.

Using a wifi extender:

- 1) Make sure the LAN cable is connected to the network port on the bottom of the ECU.
- 2) Connect the LAN cable into the wifi extender.



Figure 11

Option 3: Using a PLC bridge

- 1) Make sure the LAN cable is connected to the network port on the bottom of the ECU.

Hardware Installation

- 2) Connect the LAN cable into the “send” unit of the PLC bridge.
- 3) Connect a LAN cable from the “receive” unit of the PLC bridge into a spare port on the broadband router (refer to bridge users manual for specific operating instructions).

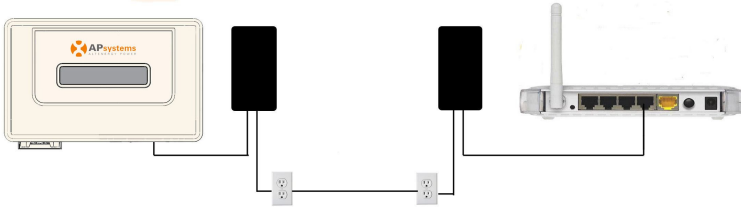

Figure 12

- NOTE:** 1. The ECU is NOT a wireless device and requires a wifi extender or bridge to make the connection to a wireless router.
2. A PLC bridge uses the power line to communicate and requires both a “send” and “receive” unit.



Connect the AC Power Line

Make sure the power cable is correctly connected to the power interface on the bottom of the ECU.

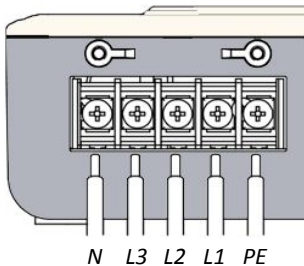

Figure 13

ECU Initialization Sequence

Once power is supplied to the ECU, it automatically steps through a series of initialization screens on its LCD display.

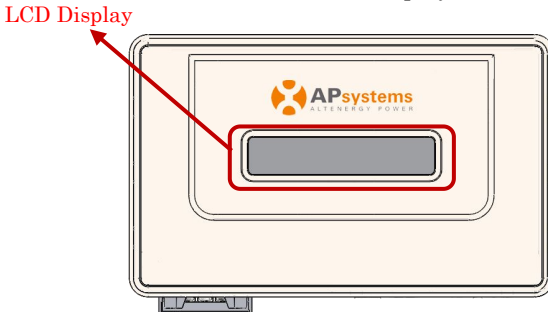

Figure 14

Step 1: Power on ECU

The following information will be displayed on LCD after ten seconds.

- 1) Loading the software firmware:

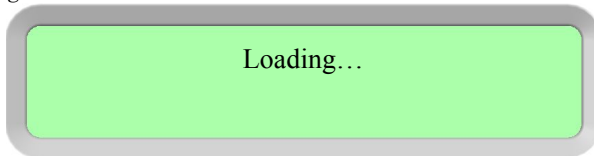

Figure 15

- 2) Searching for the inverters:

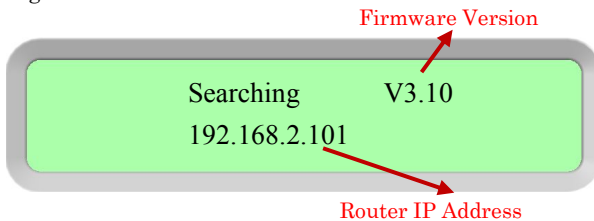

Figure 16

A word about network communication protocols. The ECU needs to have access to the router via an IP address. The ECU will only search for and obtain a Dynamic Host Configuration Protocol (DHCP) IP address during its powering up sequence.

For example, the LCD screen on the front of the ECU displays an IP address such as “192.168.2.101”, if the connection to the router is successful (the IP address will vary based on router supplier, so check with the user manual for specifics). If, however, the LED displays “60.190.131.228”, the ECU-router connection has not been successful, in which case you’ll need to check all of the cabling connections and reboot the ECU by removing the power cable for a few seconds and reconnecting.

ECU Initialization Sequence

NOTE: The complete initialization sequence can take several minutes (up to 15 minutes depending on the complexity of the installation).



3) Operation interface:

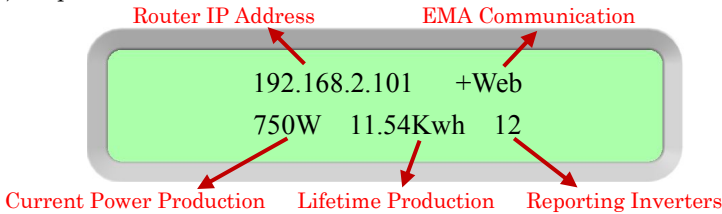

Figure 17

Router IP Address:

The LCD screen on the front of the ECU displays an IP address such as “192.168.2.101”, if the connection to the router is successful (the IP address will vary based on router supplier, so check with the user manual for specifics). If, however, the LED displays “60.190.131.228”, the ECU-router connection has not been successful, in which case you’ll need to check all of the cabling connections and reboot the ECU by removing the power cable for a few seconds and reconnecting.

EMA Communication:

A “+Web” indicates that the ECU is communicating with the APsystems EMA via the Internet. “-Web” is an indication that there is a problem and the ECU is not communicating with the APsystems EMA. Need to setup the security authority to offer Auto IP configuration.

Current Power Production:

What the solar array is producing currently (in Watts).

Lifetime Production:

The lifetime power output of the system (in kWh).

Reporting Inverters:

The number of inverters reporting into the ECU. If the number is followed by an “!”, then the number of reporting inverters does not match the number of IDs that have been programmed into the ECU.

NOTE: The inverter IDs must be programmed into the ECU for the ECU to recognize the inverters. The ECU will NOT auto-sense the inverters (see ID Management pg. 20).



ECU Initialization Sequence

Step 2: ECU time zone setting

- Enter the IP address shown on the ECU LCD into the internet browser, and then open the web page.
- Click “Administration”, then “Date, Time, Time zone”. In the corresponding box, enter local date/time/time zone, click Update after finished. For details, refer to time management on pg.24.

Step 3: EMA Monitoring

After ECU display “+Web”, contact APsystems technical staffs in your local area and they will setup an EMA account with User Name and Password, then complete EMA management(see pg.30).

Basic Operation

The APsystems ECU has one two-line, 40-character LCD display with alphanumeric. Set the mode using a single button.

NOTE: ECU functions as a gateway and monitors the microinverters that are connected to the PV modules. Therefore, the communication between inverters and ECU does not affect inverters' performance, even if ECU drops inverters. The power production data collected by ECU is for reference only, please check the power meter for the real power production of the whole system.



Menu Structure

You can access the ECU's menu by pressing and holding the Menu Button on the side of the ECU for 2 seconds.

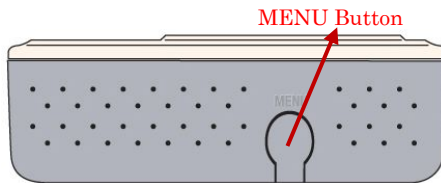

Figure 18

NOTE: The Menu Button will only cycle through its menu selections once the ECU has been successfully initialized.



The ECU has the following menu structure (displayed on LCD screen):

Exit Menu
Status
Turn off all

Figure 19

Basic Operation

Press and hold the MENU Button, releasing the button to gain access to the functionality of each menu item.

- Exit Menu: Returns the ECU to the normal operating screen (see Operating Interface Pg. 10).
- Status: Reports both the number of inverters that should be connected to the ECU (Total), and the number that are actually connected (Connected). These numbers should match.

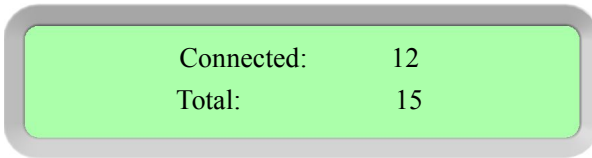

Figure 20

- Turn off all: Turn off all the entire system. Choose “Ok”, and the system of inverter will be turned off. Choose “Cancel”, ECU will exit the menu.

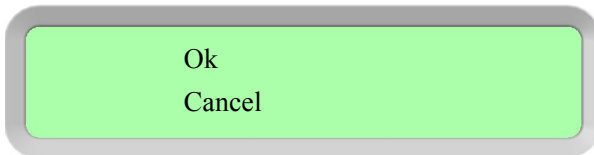

Figure 21

If within one minute without pressing the button again, then automatically exit the menu button.

NOTE: The above operation should be done under the guidance of technician.



Basic Operation

Restore the factory set operation

The following diagram guides to the connectors back of APsystems ECU.

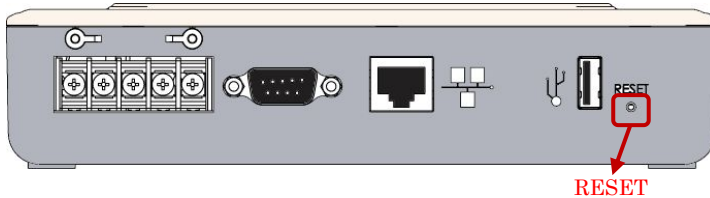

Figure 22

For the ECU restoring the factory set, simply press the “Reset” button for three seconds or longer, ECU will automatically return to the default settings.

Troubleshooting

Potential Problems and Solutions

IP Address Problem: If the IP address displayed on the ECU’s LCD does not match the subnet on your internal network and shows “60.190.131.228”, it means that it was unsuccessful in obtaining a DHCP IP address from your router.

- Check network connectivity to the router or other DHCP server. You may need to contact your Internet Service Provider or refer to your router documentation for troubleshooting assistance.

LCD Displays “-Web”: The ECU could not connect to the APsystems website.

- Check network connectivity to the router. You may need to contact your Internet Service Provider or refer to your router documentation for troubleshooting assistance

LCD Display “!”: The number of installed units doesn’t match the microinverter-count. This may indicate that the ECU is having difficulty communicating over the power lines. It could also be caused by low light levels, resulting in module voltage that is too low for the microinverter to power up.

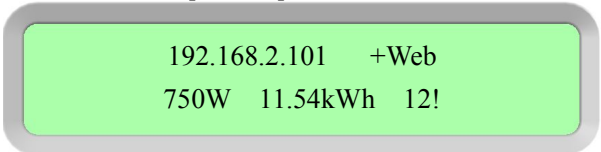

Figure 23

- Plug the ECU into an electrical socket in a different location. Keep it away from your router.

Local Network Interface

The ECU can be configured, and its data reviewed, by connecting a computer to the ECU via the Local Area Network (LAN), or by connecting directly to the ECU via its Ethernet port.

Connecting to the ECU via the LAN

1. Make sure both your computer and the ECU are correctly connected by the LAN.
2. Using a standard web browser on your computer, enter the IP Address that is displayed on your ECU in to the URL search field.

The ECU's "splash" screen is displayed.



Figure 24

Connecting Directly to the ECU

Using a Windows-based PC

1. Connect the computer to the ECU using a CAT5 network cable.
2. Power up the ECU by connecting the power cable.
3. Open the "Network and Sharing Center" in the Control Panel on the PC.
4. Select "Local Area Connection" for "Unidentified Network".
5. Select "Properties" when "Local Area Connection Status" (LAC) window is displayed.
6. Highlight "Internet Protocol Version 4 (TCP/IPv4)" when the "Local Area Connection Properties" window is displayed.
7. Select "Use the Following IP Address" radial button and the enter IP Address and Subnet Mask as listed below. Do not enter anything in the DNS Server address section.

IP Address: 60.190.131.190

Subnet Mask: 255.0.0.0

Local Network Interface

8. Select “OK” on the IPv4 Properties window.
9. Close the LAC Properties window.
10. Close the LAC Status window.
11. Close the Network and Sharing Center.
12. Using a standard web browser on your computer, enter the IP Address that is displayed on your ECU in to the URL search field.

The ECU’s “splash” screen is displayed.



Figure 25

Using an Apple Mac

1. Connect the computer to the ECU using a CAT5 network cable.
2. Power up the ECU by connecting the power cable.
3. Select the Apple icon in the menu bar to access “System Preferences”.
4. Select “Network” in the “Internet & Wireless” section of the System Preferences.
5. Select “Ethernet” on the left side of the Network window.
6. Select “Manually” from the “Configure IPv4” drop down menu.
7. Enter the following in the appropriate fields:
IP Address: 60.190.131.190
Subnet Mask: 255.0.0.0
8. Leave the “Router” field blank.
9. Select “Apply”.
10. Using a standard web browser on your computer, enter the IP Address that is displayed on your ECU in to the URL search field.

Local Network Interface

The ECU's "splash" screen is displayed.



Figure 26

Home Screen

Select "Home" at the top of the page.

The Home Page is displayed.

The screenshot shows the Home Page with a table of ECU data. The navigation bar at the top includes 'Home', 'Real Time Data', 'Configuration', and 'Administration'. The table below contains the following data:

ECU ID	20300002339
Lifetime generation	3.34 kWh
Last System Power	327 W
Generation Of Current Day	0.24 kWh
Last connection to website	2014-10-11 14:34:02
Number of Inverters	2
Last Number of Inverters Online	2
Current Software Version	V3.10
Database Size	47 kB
Current Timezone	Asia/Shanghai
ECU Mac Address	80:97:1B:00:09:8C

Figure 27

ECU ID:	This is a unique number that identifies this specific ECU.
Lifetime Generation:	Amount of power this system has generated during its lifetime.
Last System Power:	Amount of power the system was generating during its last polling cycle.
Generation of Current Day:	Amount of power that has been generated during the most current day.
Last connection to Website:	The last time the ECU checked into the central APsystems EMA database.

Local Network Interface

- Number of Inverters: Number of inverters that have programmed into the ECU.
- Last Number of Inverters Online: Number of inverters that are checking in with the ECU.
- Current Software Version: Version of software firmware.
- Database Size: Amount of data currently being stored on the ECU.
- Current Timezone: Time zone that has been programmed into the ECU.
- ECU Mac Address: The computer “machine address” of the ECU.

Real-time Data Screen

To view the real-time system operation data statistics for your solar array, click “Real Time Data” from the ECU home screen to navigate to the real-time data screen.

The Real Time Data screen is displayed.

[Home](#) [Real Time Data](#) [Configuration](#) [Administration](#)

Inverter ID	Current Power	Grid Frequency	Grid Voltage	Temperature	Date
404000099634-A	182 W	50.0 Hz	222 V	33 °C	2014-10-15 12:48:47
404000099634-B	0 W	50.0 Hz	222 V	33 °C	2014-10-15 12:48:47
404900022078-A	144 W	50.0 Hz	220 V	43 °C	2014-10-15 12:48:47
404900022078-B	0 W	50.0 Hz	220 V	43 °C	2014-10-15 12:48:47

Figure 28

Configuration Screen

The inverters are pre-programmed with system parameters with factory setting, but these parameters can be changed based on local grid and utility requirements.

WARNING: Only certified APsystems Installation Technicians should be managing the system parameters. Resetting these parameters incorrectly can severely affect system performance. Contact APsystems Technical Support BEFORE attempting to change the system parameters.



Local Network Interface

Managing System Parameters

- 1) Select “Configuration” at the top of page.
- 2) Select “Parameters”.

The Parameters screen is displayed.

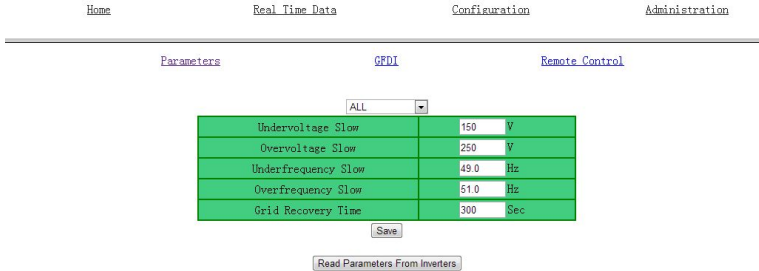

Figure 29

- 3) Make the parameter changes that are required.
- 4) Press “Save”.

It will take a few minutes for the inverter parameter changes to be reflected in the list of inverters.

Clearing GFDI Faults

- 1) Select “Configuration” at the top of page.
- 2) Select “GFDI”.

The GFDI page is displayed.

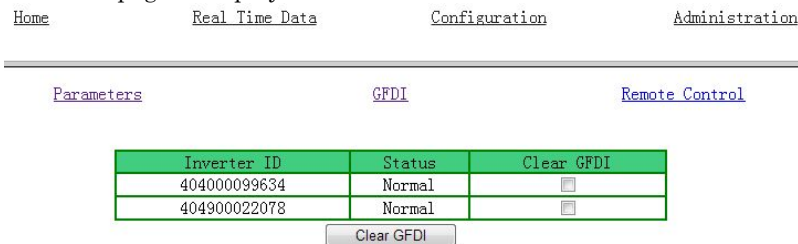

Figure 30

- 3) Place a check mark in the “Clear GFDI” column for those inverters that need to have GFDI cleared.
- 4) Press “Clear GFDI” button at the bottom of the page.

Local Network Interface

Turning ON and OFF Inverters

Individual, or all of the inverters can be turned ON and OFF through the ECU.

- 1) Select “Configuration” at the top of page.
- 2) Select “Remote Control”.

The Remote Control page is displayed.



Figure 31

If selecting individual inverters -

- 3) Place a check mark in either “Turn On” or “Turn Off” column for those inverters that need to be turned on or off.
- 4) Press “Turn On/Off” at the bottom of the page.

If turning all of the inverters On or Off -

- 3) Press either the “Turn on all inverters” or “Turn off all inverters” buttons at the bottom of the page.

Administration Screen

For the user to set up the ECU parameters

ID Management

Initial Programming of the ECU with the Inverter IDs

The “Enter Inverter ID” window field will be blank if you have not yet entered any of the inverter IDs.

- 1) Select “Administration” at the top of the page.
- 2) Select “ID Management”.

Local Network Interface

The ID Management page is displayed.

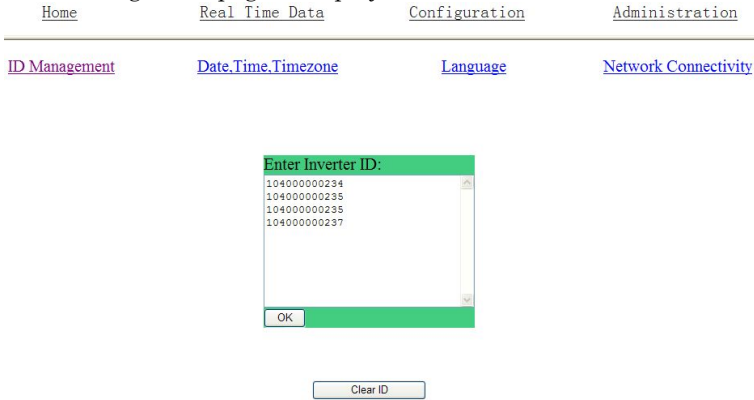

Figure 32

If manually input the inverter IDs -

- 3) Enter each 12-digit inverter ID.
- 4) Once all the ID have been entered, press "OK".

If using the Scanning Gun to scan the inverter IDs -

- 3) Copy the scanned IDs into ID Management box
- 4) Press "OK".

Adding Additional Inverter IDs

If the number of inverter ID displayed on the page is less than the actual number of inverters installed.

- 1) Select "Administration" at the top of the page.
- 2) Select "ID Management".

The ID Management page with the existing inverter IDs is displayed.

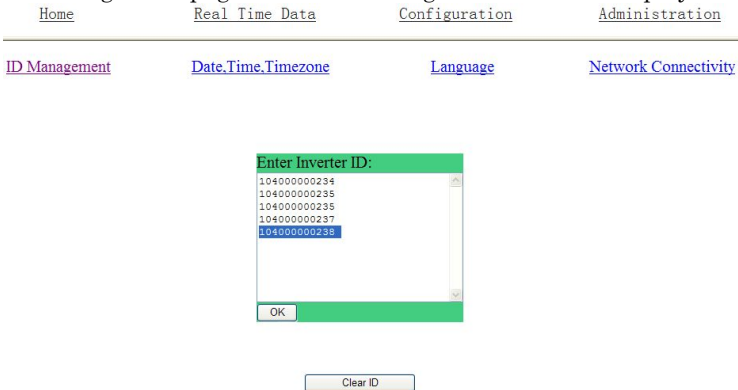

Figure 33

- 3) Scroll down to the end of the existing list.
- 4) Enter the new ID.
- 5) Press "OK".

Local Network Interface

Deleting an Existing Inverter ID

If the number of inverter ID displayed on the page is more than the actual number of inverters installed.

- 1) Select “Administration” at the top of the page.
- 2) Select “ID Management”.

The ID Management page with the existing inverter IDs is displayed.

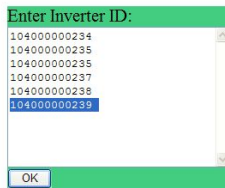

Clear ID

Figure 34

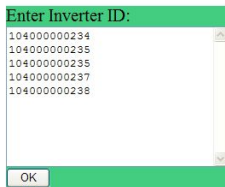

Clear ID

Figure 35

- 3) Highlight the IDs to be deleted from the list.
- 4) Press “OK”.

Modifying the wrong inverter IDs.

If the inverter ID displayed on the page is discrepancy with the actual inverters ID installed,

- 1) Select “Administration” at the top of the page.

Local Network Interface

2) Select “ID Management”.

The ID Management page with the existing inverter IDs is displayed.

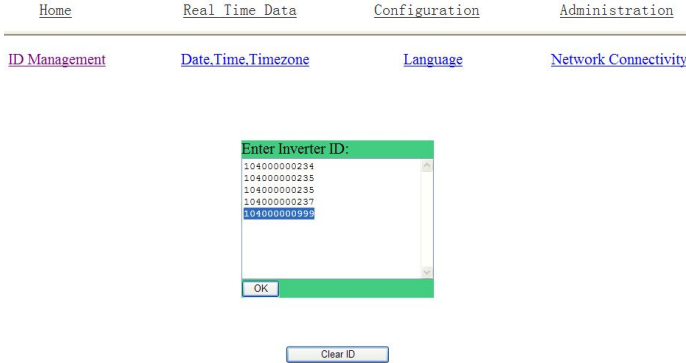

Figure 36

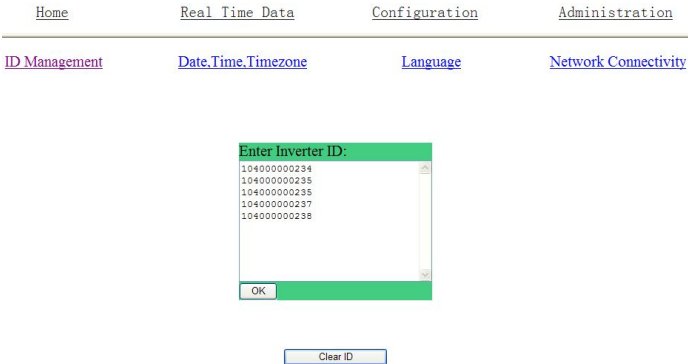

Figure 37

- 3) Highlight the IDs to be modified from the list.
- 4) Press “OK”.

Clearing all of the inverter IDs

Pressing “Clear ID” deletes ALL of the inverter IDs from the list.



Inverter ID were successfully Cleared!

Figure 38

NOTE: Combine the above two (2) steps when swapping out an inverter. Add the new inverter, and Delete the old one. Remember to follow up with the same process on the APsystems EMA because the ECU and EMA need to be in sync with each other.



Local Network Interface

Time management

It is critical for accurate power production reporting that the ECU is programmed with the correct date, time, and time zone.

- 1) Select “Administration” at the top of the page.
- 2) Select “Date, Time, Timezone”.

The Time management page is displayed.

Home Real Time Data Configuration Administration

[ID Management](#) [Date, Time, Timezone](#) [Language](#) [Network Connectivity](#)

Date:
07/11/2013
Time:
12:23:13
Update date and time

Time Zone: [Current Time Zone: Asia/Shanghai]
Select Time Zone
Update timezone

NTP Server:
0.asia.pool.ntp.org
Update NTP server setting

Figure 39

- 3) Enter the correct date in the “Date” field.
- 4) Enter the correct time in the “Time” field.
- 5) Select the correct time zone from the Time Zone pull down.

NOTE: You can skip steps 3 and 4 by select the correct time zone. Selecting the correct time zone automatically updates both the date and current time.



Language management

Users can switch language between Chinese and English.

The Language management page is displayed.

Home Real Time Data Configuration Administration

[ID Management](#) [Date, Time, Timezone](#) [Language](#) [Network Connectivity](#)

Current language: [English]
Select a language
English
Simplified Chinese

Figure 40

Local Network Interface

Network management

Users can choose to connect to the internet through GPRS or Ethernet by setting the ECU internet connection modes. The default network connection setting for the ECU is “DHCP” which allows the ECU to automatically establish a connection assignment from the router. The ECU can be assigned a static IP Address if the network design requires it.

- 1) Select “Administration” at the top of the page.
- 2) Select “Network Connectivity”.

The Network Connectivity page is displayed.

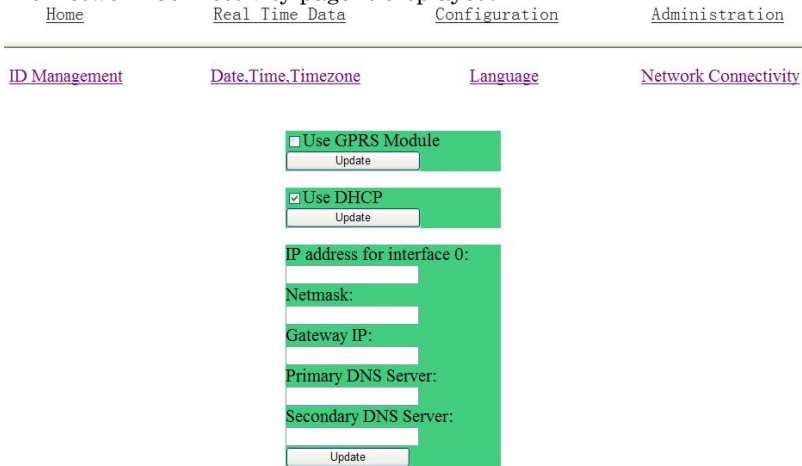

The screenshot shows the 'Network Connectivity' page within the ECU's configuration menu. At the top, there are navigation links: Home, Real Time Data, Configuration, and Administration. Below these are sub-menus: ID Management, Date, Time, Timezone, Language, and Network Connectivity. The 'Network Connectivity' section is highlighted. It contains two options: 'Use GPRS Module' (unchecked) and 'Use DHCP' (checked). Each option has an 'Update' button. Below these are fields for 'IP address for interface 0:', 'Netmask:', 'Gateway IP:', 'Primary DNS Server:', and 'Secondary DNS Server:', each with an input field and an 'Update' button at the bottom.

Figure 41

- 3) Enter the “IP Address”, “Netmask”, “Gateway IP”, “Primary DNS Server”, and “Secondary DNS Server” (Refer to you local network administrator for these settings).
- 4) Press “Update”.

NOTE: The network cable in the package could be used for the users to connect the ECU with PC directly. One side is connected with the ECU and the other side is connected with the PC. Then change the IP address and the network mask into 60.190.131.1 and 255.0.0.0 respectively.



Remote ECU Management (EMA)

The ECU has been design with remote connect functionality. You can access this remote functionality through the APsystems Energy Monitoring & Analysis [EMA] website, using your installer login credentials. Changes made remotely through the EMA do not take affect until the ECU’s next reporting cycle.

The ECU must first be installed with verified Power Line Communication [PLC] and Internet connectivity.

The ECU remote functionality allows you to do the following:

- Set Time Zones
- Manage Inverter IDs

There are additional ECU functions available but the instructions are not outlined in this document. If you need to access one of the following features, please contact APsystems Technical Support.

- Change system parameters
- Turn the inverters ON and OFF
- Reset GFDI
- Reset Power Settings

NOTE: This section of the documentation assumes you have a working knowledge of the APsystems EMA.



- 1) Log onto your APsystems EMA account. Your Customer List within the Installer Portal is displayed.
- 2) Select the customer’s ECU you want to manage and click on the pencil icon in the “Change ECU Status column”.

The screenshot shows the APsystems Installer Portal interface. At the top, there is a navigation bar with the APsystems logo and the text "INSTALLER PORTAL ENERGY MONITORING & ANALYSIS". Below the logo, there are three main navigation buttons: "CUSTOMER" (selected), "REGISTRATION", and "FAQ". To the right of these buttons are links for "Settings" and "Sign out".

The main content area displays a "Customer List" table. The table has the following columns: ID, User Account, ECU ID, User Name, Country, State, City, System Size(KW), Register Date, Change ECU Status, and Delete. There are four rows of data in the table, each with a pencil icon in the "Change ECU Status" column and a red 'X' icon in the "Delete" column.

ID	User Account	ECU ID	User Name	Country	State	City	System Size(KW)	Register Date	Change ECU Status	Delete
1	PVUSA	20300008668	Steve Coonen	United States	California	Davis		2014-02-07		
2	APSAbackshop	20300008730	John Doerr	United States	Washington	Poulsbo		2014-01-21		
3	NDrobin	20300008657	Nick Drobin	United States	WA	Bellevue	10	2013-12-20		
4	MLarson	20300008550	Mike Larson	United States	Washington	Mercer Island	4.3	2013-10-24		

At the bottom of the table, it says "4 results found, displaying 1 to 4". On the right side of the table, there are links for "First", "Prev", "Next", and "Last".

Figure 42

Remote ECU Management (EMA)

ECU Configuration/ECU Status Page

The ECU SETTING page is your entry point into managing ECUs remotely.

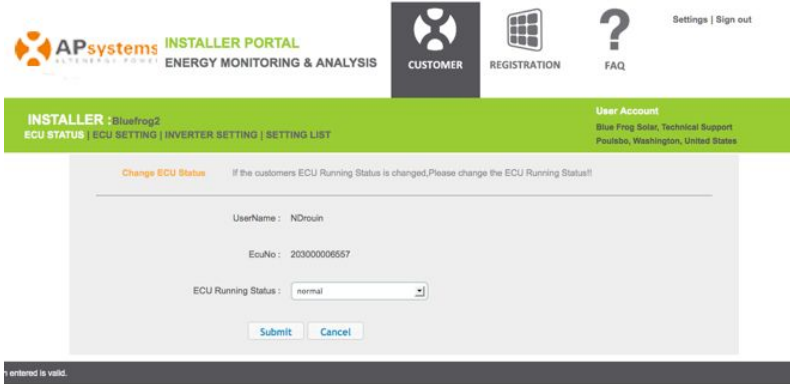

Figure 43

The ECU SETTING tab allows you to:

Set Time Zones

- The ECU time zone can set or adjusted remotely through the ECU setting tab. If the time zone is not properly set the solar production data will not post properly on the EMA site.

Load Inverter IDs

- Once the ECU has been installed you can access the ECU remotely to add the inverter IDs. Until the inverter IDs are loaded, the ECU will not be able to collect data from the inverters.

Update Inverter ID list

- If an inverter(s) is added or swapped for a new unit, then the ECU's programmed list of inverters will need to be updated.

Remote ECU Management (EMA)

Setting the ECU Time Zone

- 1) Select the “ECU SETTING” tab.
The ECU Configuration page is displayed.

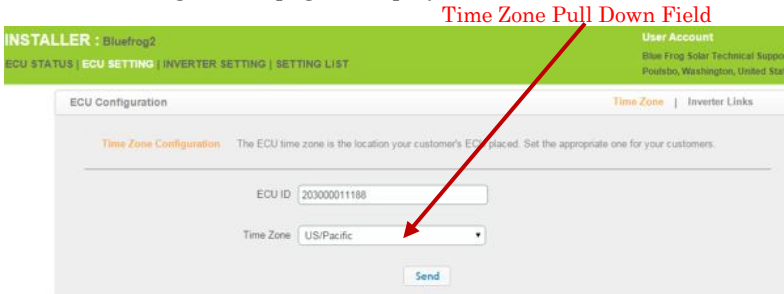

Figure 44

- 2) Using the “Time Zone” pull down field, select the appropriate time zone.
- 3) Press “Send”.

Managing Inverter IDs and Updating the Inverter ID List

- 1) Select the “ECU SETTING” tab.
 - 2) Select the “Inverter Links” tab.
- The Inverter Links Configuration page is displayed

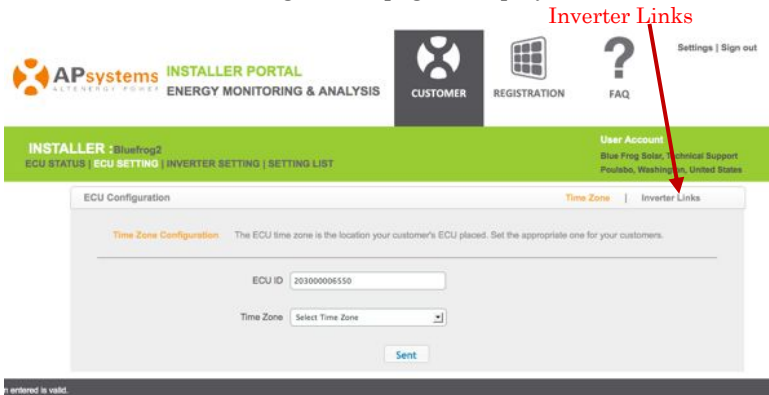

Figure 45

Remote ECU Management (EMA)

Operation Selection (Add or Delete)

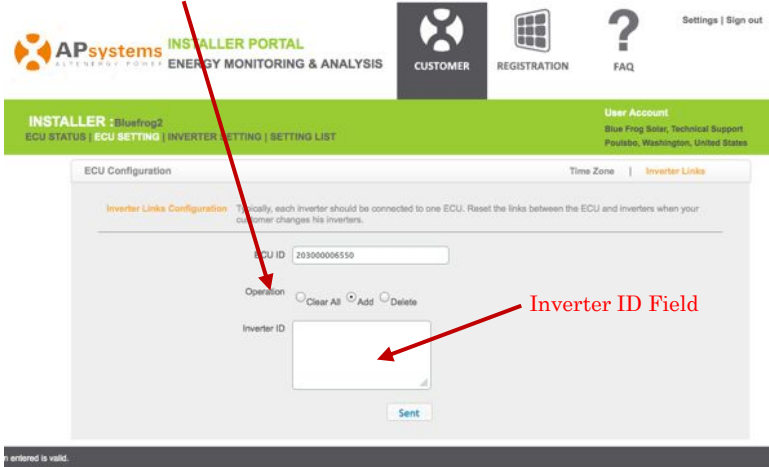

Figure 46

Adding Complete List of Inverter IDs for a Newly Installed System

There are three different approaches to add the inverter IDs:

Option 1: Manually input the inverter IDs -

- 1) Select “Add” in Operation Selection.
- 2) Enter all of the inverter IDs into the Inverter ID Field (one per line).
- 3) Press “Sent”.

Option 2: Using the Scanning Gun to scan the inverter IDs -

- 1) Select “Add” in Operation Selection.
- 2) Copy the scanned IDs into the Inverter ID Field (one per line).
- 3) Press “Sent”.

Option 3: Scan the inverter IDs by mobile phone -

- 1) Log onto EMA App.
- 2) Scan the inverter IDs.

Delete IDs from Inverter List

- 1) Select “Delete” in Operation Selection.
- 2) Enter all of the inverters to be removed from the Inverter ID Field.
- 3) Press “Sent”.

Technical Data

Model: Three-phase ECU-3	
Version: 3	
Communication Interface	
Power Line	Five core power line
Ethernet	10/100M Auto-sensing, Auto-negotiation
USB interface	Standard
RS232	Standard
Power Requirements	
AC Outlet	120V/280V or 230V/400V, 50~60 Hz
Power Consumption	2.5 W
Mechanical Data	
Dimensions(W×H×D)	182 mm×113 mm×42 mm (7.1''×4.4''×1.6'')
Weight	380 g (0.83lbs)
Ambient Temperature Range	-40°C to +65°C
Cooling	Nature Convection; No Fans
Enclosure	Indoor - NEMA 1(IP30)
Environmental Rating	
Features	
Compliance	IEC 60950-1, EN60950-1, IEC 60529, EN 60529, ANSI/UL 60950-1, CAN/CSA C22.2 No.60950-1, UL50E, FCC part 15, EN61000-6-1, EN61000-6-3, ICES-003, AS NZS 60950-1, GB/T17799

Specifications subject to change without notice -

Please ensure you are using the most recent update found at www.APsystems.com.

This device complies with part 15 of the FCC Rules. Operation is subject to the following two conditions: (1) This device may not cause harmful interference, and (2) this device must accept any interference received, including interference that may cause undesired operation.

This Class B digital apparatus complies with Canadian ICES-003.

:: WEEE (for Europe)



Disposal of your old appliance

1. When this crossed-out wheeled bin symbol is attached to a product, it means the product is covered by the European Directive 2002/96/EC.
2. All electrical and electronic products should be disposed of separately from the municipal waste stream via designated collection facilities appointed by the government or the local authorities.
3. The correct disposal of your old appliance will help prevent potential negative consequences for the environment and human health.
4. For more detailed information about disposal of your old appliance, please contact your city office, waste disposal service or the shop where you purchased the product.

Contact Information

ALTENERGY POWER SYSTEM Inc.

Web: www.APsystems.com

APsystems Jiaxing China

No. 1, Yatai Road, Nanhu District, Jiaxing, Zhejiang

Tel: +86 573 8398 6967

Mail: info@altenergy-power.com

APsystems Shanghai China

B403 No. 188, Zhangyang Road, Pudong, Shanghai

Tel: +86 021 3392 8205

Mail: info@altenergy-power.com

APsystems Australia

Suite 502, 8 Help Street, Chatswood NSW 2067 Australia

Tel: +61 (0)2 8034 6587

Mail: info@altenergy-power.com

APsystems America

600 Ericksen Ave NE, Suite 200 Seattle, WA 98110

Tel: 844-666-7035

Mail: info@apsamerica.com

APsystems Europe

Cypresbaan 7,2908LT, Capelle aan den IJssel, The Netherlands

Tel: +0031-10-2582670

Mail: info@altenergy-power.com